

GARMIN.

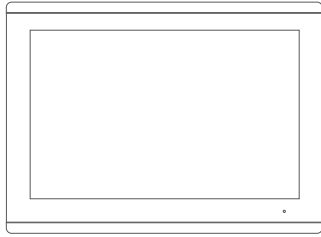

# GPSMAP® 7X3/9X3/12X3 INSTALLATION INSTRUCTIONS

## Important Safety Information

### ⚠ WARNING

Failure to follow these warnings, cautions, and notices could result in personal injury, damage to the vessel or device, or poor product performance.

See the *Important Safety and Product Information* guide in the product box for product warnings and other important information.

When connecting the power cable, do not remove the in-line fuse holder. To prevent the possibility of injury or product damage caused by fire or overheating, the appropriate fuse must be in place as indicated in the product specifications. In addition, connecting the power cable without the appropriate fuse in place voids the product warranty.

### ⚠ CAUTION

To avoid possible personal injury, always wear safety goggles, ear protection, and a dust mask when drilling, cutting, or sanding.

To avoid possible personal injury or damage to the device and vessel, disconnect the vessel's power supply before beginning to install the device.

To avoid possible personal injury or damage to the device or vessel, before applying power to the device, make sure that it has been properly grounded, following the instructions in the guide.

### NOTICE

For the best possible performance, the device must be installed according to these instructions.

When drilling or cutting, always check what is on the opposite side of the surface to avoid damaging the vessel.

Read all installation instructions before proceeding with the installation. If you experience difficulty during the installation, contact Garmin® Product Support.

### Tools Needed

- Drill
- Drill bits appropriate for the device and mounting style

Mounting style	Drill bit sizes
Bail with included wood screws	3 mm (1/8 in.)
Flush for the corner of the cutout	GPSMAP 7x3: 6.5 mm (1/4 in.) GPSMAP 9x3: 7.4 mm (5/16 in.) GPSMAP 12x3: 13.5 mm (9/16 in.)
Flush with included wood screws	3.5 mm (9/64 in.)
Flush with included machine screws and nut plates	3.5 mm (9/64 in.) 3 mm (1/8 in.)
Flush with included machine screws and tapped holes	M3 tap

- #2 Phillips screwdriver
- Jigsaw or rotary tool
- File and sandpaper
- Marine sealant (recommended)

## GPSMAP 7x3 and GPSMAP 9x3 Connector View

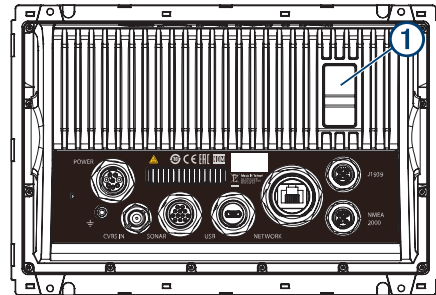

POWER	Power and NMEA® 0183 network
NETWORK	Garmin Marine Network
J1939	J1939 engine network
⏏	Ground screw
CVBS IN	Composite video in
SONAR	12-pin transducer (Not available on all models)
USB	Micro-USB for compatible Garmin card reader
NMEA 2000	NMEA 2000® network
①	2 microSD® memory card slots, 32 GB max.

## GPSMAP 12x3 Connector View

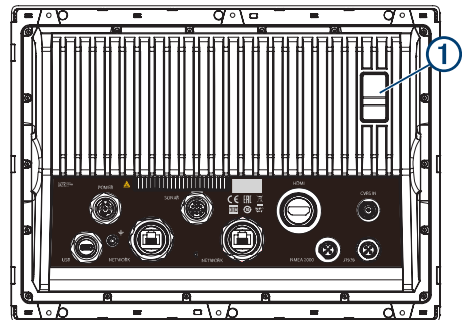

POWER	Power and NMEA 0183 network
SONAR	12-pin transducer (Not available on all models)
HDMI	HDMI® video out
CVBS IN	Composite video in
USB	Micro-USB for compatible Garmin card reader



	Ground screw
NETWORK	Garmin Marine Network
NMEA 2000	NMEA 2000 network
J1939	Engine or J1939 network
①	2 microSD memory card slots, 32 GB max.

## Contacting Garmin Support

- Go to [support.garmin.com](http://support.garmin.com) for help and information, such as product manuals, frequently asked questions, videos, and customer support.
- In the USA, call 913-397-8200 or 1-800-800-1020.
- In the UK, call 0808 238 0000.
- In Europe, call +44 (0) 870 850 1241.

## Software Update

You may need to update the chartplotter software after installation. For the instructions on how to update the software, see the owner's manual at [garmin.com/manuals/GPSMAP7x3-9x3-12x3](http://garmin.com/manuals/GPSMAP7x3-9x3-12x3).

## Mounting Considerations

### NOTICE

This device should be mounted in a location that is not exposed to extreme temperatures or conditions. The temperature range for this device is listed in the product specifications. Extended exposure to temperatures exceeding the specified temperature range, in storage or operating conditions, may cause device failure. Extreme-temperature-induced damage and related consequences are not covered by the warranty.

When selecting a mounting location, you should observe these considerations.

- The location should provide optimal viewing as you operate your boat.
- The location should allow for easy access to all device interfaces, such as the keypad, touchscreen, and card reader, if applicable.
- The location must be strong enough to support the weight of the device and protect it from excessive vibration or shock.
- To avoid interference with a magnetic compass, the device should not be installed closer to a compass than the compass-safe distance value listed in the product specifications.
- The location must allow room for the routing and connection of all cables.
- The location must not be a flat, horizontal surface. The location should be in a vertical angle.

The location and viewing angle should be tested before you install the device. High viewing angles from above and below the display may result in a poor image.

## Bail Mounting the Device

### NOTICE

If you are mounting the bracket on fiberglass with screws, it is recommended to use a countersink bit to drill a clearance counterbore through only the top gel-coat layer. This will help to avoid cracking in the gel-coat layer when the screws are tightened.

You can use the bracket to bail mount the device on a flat surface.

- 1 Using the bail-mount bracket ① as a template, mark the pilot holes ②.

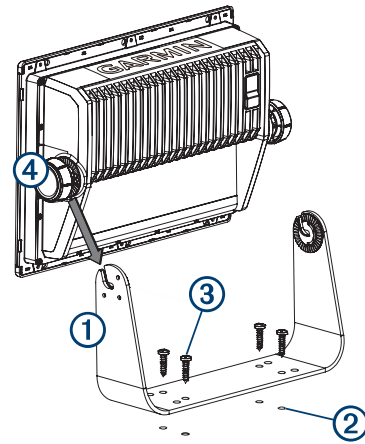

- 2 Using a 3 mm ( $\frac{1}{8}$  in.) drill bit, drill the pilot holes.
- 3 Secure the bail-mount bracket to the surface using the included washers and wood screws ③.
- 4 Install the bail-mount knobs ④ on the sides of the device.
- 5 Place the device in the bail-mount bracket, and tighten the bail-mount knobs.
- 6 Install the trim caps by snapping them in place around the edges of the device.

## Flush Mounting the Device

### NOTICE

Be careful when cutting the hole to flush mount the device. There is only a small amount of clearance between the case and the mounting holes, and cutting the hole too large could compromise the stability of the device after it is mounted.

Use only the included hardware when mounting this device. Using mounting hardware not provided with the device may damage the device.

To avoid potential damage to the powder coating, use only the included screws to mount the device. Using screws other than the ones included will void your warranty.

Do not use the device as a template when drilling the mounting holes because this may damage the glass display and void the warranty. You must only use the included template to correctly drill the mounting holes.

If you will not have access to the back of the device and the microSD memory card slots after installations, you should install the microSD memory card prior to installation.

The included template and hardware can be used to flush mount the device in your dashboard. There are three options for hardware based on the mounting surface material.

- You can drill pilot holes and use the included wood screws.
  - You can drill holes and use the included nut plates and machine screws. The nut plates can add stability to a thinner surface.
  - You can punch and tap holes, and use the included machine screws.
- 1 Trim the template, and make sure it fits in the location where you want to mount the device.
  - 2 Secure the template to the mounting location.
  - 3 Using a drill bit according to the list below, drill one or more of the holes inside the corners of the solid line on the template to prepare the mounting surface for cutting.

Device	Drill bit size
GPSMAP 7x3	6.5 mm ( $\frac{1}{4}$ in.)
GPSMAP 9x3	7.4 mm ( $\frac{5}{16}$ in.)
GPSMAP 12x3	13.5 mm ( $\frac{9}{16}$ in.)

- 4 Using a jigsaw or a rotary tool, cut the mounting surface along the inside line on the template.
- 5 Place the device in the cutout to test the fit.
- 6 If necessary, use a file and sandpaper to refine the size of the cutout.
- 7 If necessary, remove the trim caps.

### NOTICE

Use a plastic pry tool when possible. Using a metal pry tool, such as a screwdriver, can damage the trim caps and the device.

- 8 After the device fits correctly in the cutout, ensure the mounting holes on the device line up with the hole locations on the template.
 

**NOTE:** GPSMAP 12x3 models have six mounting holes. GPSMAP 9x3 and GPSMAP 7x3 models have four mounting holes.
- 9 If the mounting holes on the device do not line up, mark the new hole locations.
- 10 Based on your mounting method, drill or punch and tap the outer holes on the template:
  - For the included wood screws, drill 3.5 mm ( $9/64$  in.) holes, and skip to step 18.
  - For the included nut plate and machine screws, drill 3.5 mm ( $9/64$  in.) holes in the outer hole locations.
  - For the included machine screws without the nut plate, punch and tap M3 holes, and skip to step 18.
- 11 If you are using a nut plate, starting in one corner of the template, place a nut plate ① over the hole ② drilled in the previous step.

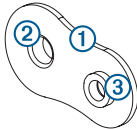

The other hole ③ on the nut plate should line up with the inner hole on the template.

- 12 If the inner hole on the nut plate does not line up with the inner hole on the template, mark the new hole location.
- 13 If you are using a nut plate, using a 3 mm ( $1/8$  in.) drill bit, drill a hole in the inner hole location.
- 14 Repeat to verify placement of the remaining nut plates and holes on the template.
- 15 Remove the template from the mounting surface.
- 16 Starting in one corner of the mounting location, place a nut plate ④ on the back of the mounting surface, lining up the holes.

The raised portion of the nut plate should fit into the inner hole.

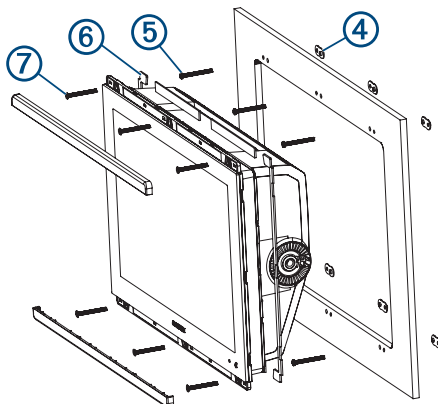

- 17 Secure the nut plates to the mounting surface by fastening the pan head machine screws ⑤ through the inner holes.
- 18 Install the foam gasket ⑥ on the back of the device.
 

The pieces of the foam gasket have adhesive on the back. Make sure you remove the protective liner before installing them on the device.
- 19 If you will not have access to the back of the device after you mount it, connect all necessary cables and install microSD cards in the back of the device before placing it into the cutout.

### NOTICE

To prevent corrosion of the metal contacts, cover unused connectors with the attached weather caps.

- 20 Apply marine sealant between the mounting surface and the device to properly seal and prevent leakage behind the dashboard.
- 21 If you will have access to the back of the device, apply marine sealant around the cutout.
- 22 Place the device into the cutout.
- 23 Secure the device to the mounting surface using the flat head machine screws ⑦ or the included wood screws.
- 24 Wipe away all excess marine sealant.
- 25 Install the trim caps by snapping them in place around the edges of the device.

## Connection Considerations

After connecting the cables to the device, tighten the locking rings to secure each cable.

### Power/NMEA 0183 Cable

- The wiring harness connects the device to power, NMEA 0183 devices, and a lamp or a horn for visible or audible alerts.
- If it is necessary to extend the NMEA 0183 or alarm wires, you must use 22 AWG (.33 mm<sup>2</sup>) wire.
- This cable provides one differential NMEA 0183 input and output port.

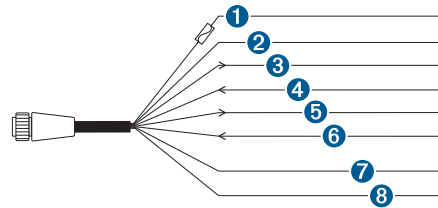

Item	Wire Color	Wire Function
①	Red	Power
②	Black	Ground (power and NMEA 0183)
③	Blue	NMEA 0183 TxA (Out +)
⑤	Gray	NMEA 0183 TxB (Out -)
④	Brown	NMEA 0183 RxA (In +)
⑥	Violet	NMEA 0183 RxB (In -)
⑦	Orange	Accessory on
⑧	Yellow	Alarm low

### Connecting the Wiring Harness to Power

#### ⚠ WARNING

When connecting the power cable, do not remove the in-line fuse holder. To prevent the possibility of injury or product damage caused by fire or overheating, the appropriate fuse must be in place as indicated in the product specifications. In

addition, connecting the power cable without the appropriate fuse in place voids the product warranty.

- 1 Route the wiring harness to the power source and to the device.
- 2 Connect the red wire to the positive (+) battery terminal, and connect the black wire to the negative (-) battery terminal.
- 3 If necessary, install the locking ring and O-ring on the end of the wiring harness.
- 4 Insert the cable into the POWER connector on the back of the device, pushing firmly.
- 5 Turn the locking ring clockwise to attach the cable to the device.

#### Additional Grounding Consideration

This device should not need additional chassis grounding in most installation situations. If you experience interference, the grounding screw on the housing can be used to connect the device to the water ground of the boat to help avoid the interference.

### Garmin Marine Network Considerations

#### NOTICE

A Garmin Marine Network PoE Isolation Coupler (010-10580-10) must be used when connecting any third-party device, such as a FLIR® camera, to a Garmin Marine Network. Connecting a Power over Ethernet (PoE) device directly to a Garmin Marine Network chartplotter damages the Garmin chartplotter and may damage the PoE device. Connecting any third-party device directly to a Garmin Marine Network chartplotter will cause abnormal behavior on the Garmin devices, including the devices not properly turning off or the software becoming inoperable.

This device can connect to additional Garmin Marine Network devices to share data such as radar, sonar, and detailed mapping. When connecting Garmin Marine Network devices to this device, observe these considerations.

- All devices connected to the Garmin Marine Network must be connected to the same ground. If multiple power sources are used for Garmin Marine Network devices, you must tie all ground connections from all power supplies together using a low resistance connection or tie them to a common ground bus bar, if available.
- A Garmin Marine Network cable must be used for all Garmin Marine Network connections.
  - Third-party CAT5 cable and RJ45 connectors must not be used for Garmin Marine Network connections.
  - Additional Garmin Marine Network cables and connectors are available from your Garmin dealer.
- The NETWORK ports on the device each act as a network switch. Any compatible device can be connected to any NETWORK port to share data with all devices on the boat connected by a Garmin Marine Network cable.

### NMEA 2000 Considerations

#### NOTICE

If you are connecting to an **existing** NMEA 2000 network, identify the NMEA 2000 power cable. Only one NMEA 2000 power cable is required for the NMEA 2000 network to operate properly.

A NMEA 2000 Power Isolator (010-11580-00) should be used in installations where the existing NMEA 2000 network manufacturer is unknown.

If you are installing a NMEA 2000 power cable, you must connect it to the boat ignition switch or through another in-line switch. NMEA 2000 devices will drain your battery if the NMEA 2000 power cable is connected to the battery directly.

This device can connect to a NMEA 2000 network on your boat to share data from NMEA 2000 compatible devices such as a GPS antenna or a VHF radio. The included NMEA 2000 cables and connectors allow you to connect the device to your existing NMEA 2000 network. If you do not have an existing NMEA 2000 network you can create a basic one using cables from Garmin.

If you are unfamiliar with NMEA 2000, you should read the *Technical Reference for NMEA 2000 Products* at [garmin.com/manuals/nmea\\_2000](http://garmin.com/manuals/nmea_2000).

The port labeled NMEA 2000 is used to connect the device to a standard NMEA 2000 network.

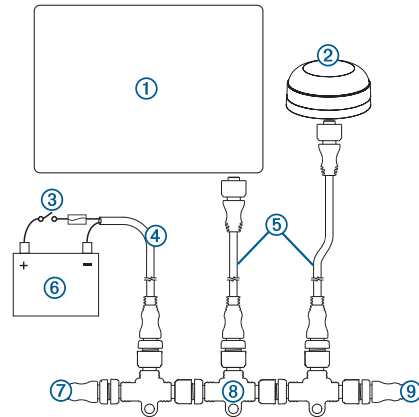

Item	Description
①	NMEA 2000 compatible Garmin device
②	GPS antenna
③	Ignition or in-line switch
④	NMEA 2000 power cable
⑤	NMEA 2000 drop cable
⑥	12 Vdc power source
⑦	NMEA 2000 terminator or backbone cable
⑧	NMEA 2000 T-connector
⑨	NMEA 2000 terminator or backbone cable

### NMEA 0183 Connection Considerations

- The chartplotter provides one Tx (transmit) port and one Rx (receive) port.
- Each port has 2 wires, labeled A and B according to the NMEA 0183 convention. The corresponding A and B wires of each internal port should be connected to the A (+) and B (-) wires of the NMEA 0183 device.
- You can connect one NMEA 0183 device to the Rx port to input data to this chartplotter, and you can connect up to three NMEA 0183 devices in parallel to the Tx port to receive data output by this chartplotter.
- See the NMEA 0183 device installation instructions to identify the transmit (Tx) and receive (Rx) wires.
- You must use 28 AWG, shielded, twisted-pair wiring for extended runs of wire. Solder all connections and seal them with heat-shrink tubing.
- Do not connect the NMEA 0183 data wires from this device to power ground.
- The power cable from the chartplotter and the NMEA 0183 devices must be connected to a common power ground.
- The internal NMEA 0183 ports and communication protocols are configured on the chartplotter. See the NMEA 0183 section of the chartplotter owner's manual for more information.



- See the chartplotter owner's manual for a list of the approved NMEA 0183 sentences that the chartplotter supports.

### NMEA 0183 Device Connections

This diagram illustrates two-way connections for both sending and receiving data. You can also use this diagram for one-way communication. To receive information from a NMEA 0183 device, refer to items ①, ②, ③, and ④ when connecting the Garmin device. To transmit information to a NMEA 0183 device, refer to items ①, ②, ⑤, and ⑥ when connecting the Garmin device.

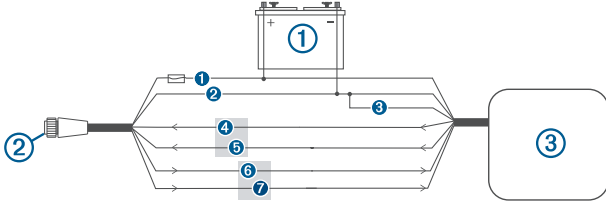

Item	Description
①	Power source
②	Power/NMEA 0183 cable
③	NMEA 0183 device

Item	Garmin Wire Function	Garmin Wire Color	NMEA 0183 Device Wire Function
①	Power	Red	Power
②	Power ground	Black	Power ground
③	Data ground	Black	Data ground
④	Rx/A (In +)	Brown	Tx/A (Out +)
⑤	Rx/B (In -)	Violet	Tx/B (Out -)
⑥	Tx/A (Out +)	Blue	Rx/A (In +)
⑦	Tx/B (Out -)	Gray	Rx/B (In -)

If the NMEA 0183 device has only one input (receive, Rx) wire (no A, B, +, or -), you must leave the gray wire unconnected.  
If the NMEA 0183 device has only one output (transmit, Tx) wire (no A, B, +, or -), you must connect the violet wire to ground.

### NMEA 0183 and Power Cable Pinout

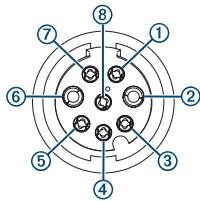

Pin Number	Wire Function	Wire Color
③	NMEA 0183 Tx/A (Out +)	Blue
④	NMEA 0183 Rx/A (In +)	Brown
①	NMEA 0183 Tx/B (Out -)	Gray
⑦	NMEA 0183 Rx/B (In -)	Violet
⑤	Alarm	Yellow
⑧	Accessory on	Orange
②	Ground (shield)	Black
⑥	VIN	Red

### Lamp and Horn Connections

The device can be used with a lamp, a horn, or both, to sound or flash an alert when the chartplotter displays a message. This is optional, and the alarm wire is not necessary for the device to function normally. When connecting the device to a lamp or horn, observe these considerations.

- The alarm circuit switches to a low-voltage state when the alarm sounds.
- The maximum current is 100 mA, and a relay is needed to limit the current from the chartplotter to 100 mA.
- To manually toggle visual and audible alerts, you can install single-pole, single-throw switches.

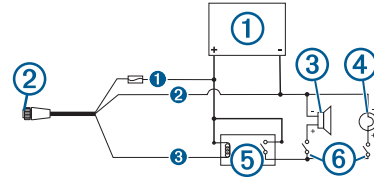

Item	Description
①	Power source
②	Power cable
③	Horn
④	Lamp
⑤	Relay (100 mA coil current)
⑥	Toggle switches to enable and disable lamp or horn alerts

Item	Wire Color	Wire Function
①	Red	Power
②	Black	Ground
③	Yellow	Alarm

### J1939 Engine Network Connection Considerations

#### NOTICE

You must use a Garmin GPSMAP J1939 accessory cable when connecting the chartplotter to the J1939 engine network to prevent corrosion due to moisture. Using a different cable voids your warranty.

If you have an existing engine network on your boat, it should already be connected to power. Do not add any additional power supply.

This chartplotter can connect to an engine network on your boat to read data from compatible devices such as certain engines. The engine network follows a standard and uses proprietary messages.

You should connect only one chartplotter to one engine network. Connecting more than one chartplotter to one engine network may result in unexpected behavior.

The port labeled J1939 is used to connect the device to the existing engine network. You must route the cable within 6 m (20 ft.) of the engine network backbone.

The Garmin GPSMAP J1939 accessory cable requires connection to a power source and proper termination. For more information on connecting to your engine network, see the manufacturer's engine documentation.

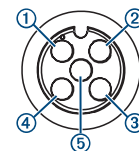

Pin	Wire Color	Description
①	Bare	Shield
②	Red	Power, positive
③	Black	Power, negative
④	White	CAN High
⑤	Blue	CAN Low

### Composite Video Considerations

This chartplotter allows video input from composite video sources using the port labeled CVBS IN. When connecting composite video, you should observe these considerations.

- The CVBS IN port uses a BNC connector. You can use a BNC to RCA adapter to connect a composite-video source with RCA connectors to the CVBS IN port.
- Video is shared across the Garmin Marine Network, but it is not shared across the NMEA 2000 network.

### HDMI Out Video Considerations

#### NOTICE

To prevent corrosion due to moisture, you must use Garmin GPSMAP accessory cables when connecting the chartplotter to the video display. Using different cables voids your warranty.

The GPSMAP 12x3 chartplotter has HDMI out capability to duplicate the chartplotter screen on another device, such as a television or monitor.

The Garmin GPSMAP HDMI accessory cable is 4.5 m (15 ft.) long. If you need a longer cable, you should use an active HDMI cable only. You need an HDMI coupler to connect the two HDMI cables.

You must make all cable connections in a dry environment.

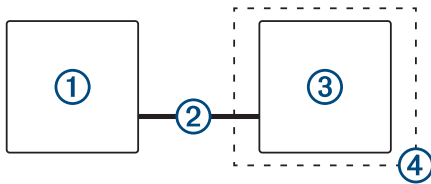

Item	Description
①	GPSMAP 12x3 chartplotter
②	GPSMAP HDMI cable (HDMI)
③	Display with an HDMI In port, such as a computer or television
④	Dry environment, protected from moisture

### Installing the Ferrite Beads on the Cables

To comply with regulations and to reduce noise, you can install the included ferrite beads on the specified cables.

GPSMAP 12x3	Power cable and transducer cable
GPSMAP 7x3/9x3	Power cable, transducer cable, and USB cable

Securely snap one ferrite bead around each of the specified cables, as close to the connectors as possible.

## Specifications

### All Models

Temperature range	From -15° to 55°C (from 5° to 131°F)
Material	Polycarbonate plastic and die-cast aluminum

Water rating	IEC 60529 IPX7 <sup>1</sup>
Input voltage	From 10 to 32 Vdc
Fuse	6 A, 125 V fast-acting
NMEA 2000 LEN @ 9 Vdc	2
NMEA 2000 draw	75 mA max.
USB connector	Micro-USB for compatible Garmin card reader <sup>2</sup>
Wireless frequency	2.4 GHz @ 18.3 dBm maximum
Memory card	2 microSD card slots; 32 GB max. card size

### GPSMAP 7x3

Dimensions (W × H × D)	192.3 × 140.3 × 74.1 mm (7 <sup>9</sup> / <sub>16</sub> × 5 <sup>1</sup> / <sub>2</sub> × 2 <sup>15</sup> / <sub>16</sub> in.)
Clearance to next obstruction	27.8 mm (2 in.)
Display size (W × H)	154.6 × 91.0 mm (6 <sup>1</sup> / <sub>16</sub> × 3 <sup>9</sup> / <sub>16</sub> in.) 17.8 cm (7.0 in.) diagonal
Display resolution	WSVGA, 1024 × 600 pixels
Weight	1.3 kg (2.8 lb.)
Compass-safe distance	35 cm (13.78 in.)
Max. power usage at 10 Vdc	Non-sonar models: 17.6 W Sonar models: 35.9 W
Typical current draw at 12 Vdc	Non-sonar models: 1.08 A Sonar models: 1.18 A
Max. current draw at 12 Vdc	Non-sonar models: 1.45 A Sonar models: 2.96 A

### GPSMAP 9x3

Dimensions (W × H × D)	233.0 × 162.3 × 75.8 mm (9 <sup>3</sup> / <sub>16</sub> × 6 <sup>3</sup> / <sub>8</sub> × 3 in.)
Clearance to next obstruction	33.2 mm (1 <sup>5</sup> / <sub>8</sub> in.)
Display size (W × H)	198.7 × 111.8 mm (7 <sup>13</sup> / <sub>16</sub> × 4 <sup>3</sup> / <sub>8</sub> in.) 22.9 cm (9.0 in.) diagonal
Display resolution	WXGA, 1280 × 720 pixels
Weight	1.6 kg (3.6 lb.)
Compass-safe distance	30 cm (11.81 in.)
Max. power usage at 10 Vdc	Non-sonar models: 22.0 W Sonar models: 40.2 W
Typical current draw at 12 Vdc	Non-sonar models: 1.34 A Sonar models: 1.37 A
Max. current draw at 12 Vdc	Non-sonar models: 1.78 A Sonar models: 3.20 A

### GPSMAP 12x3

Dimensions (W × H × D)	308.3 × 227.6 × 81.8 mm (12 <sup>1</sup> / <sub>8</sub> × 8 <sup>15</sup> / <sub>16</sub> × 3 <sup>1</sup> / <sub>4</sub> in.)
Clearance to next obstruction	18.7 mm ( <sup>3</sup> / <sub>4</sub> in.)
Display size (W × H)	262.1 × 164.2 mm (10 <sup>15</sup> / <sub>16</sub> × 6 <sup>7</sup> / <sub>16</sub> in.) 30.7 cm (12.1 in.) diagonal
Display resolution	WXGA, 1280 × 800 pixels
Weight	3.0 kg (6.6 lb.)
Compass-safe distance	45 cm (17.72 in.)
Max. power usage at 10 Vdc	Non-sonar models: 26.5 W Sonar models: 43.0 W
Typical current draw at 12 Vdc	Non-sonar models: 1.67 A Sonar models: 1.68 A
Max. current draw at 12 Vdc	Non-sonar models: 2.15 A Sonar models: 3.56 A

<sup>1</sup> The device withstands incidental exposure to water of up to 1 m for up to 30 min. For more information, go to [www.garmin.com/waterrating](http://www.garmin.com/waterrating).

<sup>2</sup> Only compatible Garmin card readers recommended. Third-party card readers are not guaranteed to be fully compatible.

## NMEA 2000 PGN Information

### Transmit and Receive

PGN	Description
059392	ISO acknowledgment
059904	ISO request
060160	ISO transport protocol: Data transfer
060416	ISO transport protocol: Connection management
060928	ISO address claimed
065240	Commanded address
126208	Request group function
126996	Product information
126998	Configuration information
127237	Heading/track control
127245	Rudder
127250	Vessel heading
127258	Magnetic variance
127488	Engine parameters: Rapid update
127489	Engine parameters: Dynamic
127493	Transmission parameters: Dynamic
127505	Fluid level
127508	Battery status
128259	Speed: Water referenced
128267	Water depth
129025	Position: Rapid update
129026	COG and SOG: Rapid update
129029	GNSS position data
129283	Cross track error
129284	Navigation data
129539	GNSS DOPs
129540	GNSS satellites in view
130060	Label
130306	Wind data
130310	Environmental parameters (obsolete)
130311	Environmental parameters (obsolete)
130312	Temperature (obsolete)

### Transmit

PGN	Description
126464	Transmit and receive PGN list group function
126984	Alert Response
127497	Trip parameters: Engine

### Receive

PGN	Description
065030	Generator average basic AC quantities (GAAC)
126983	Alert
126985	Alert text
126987	Alert threshold
126988	Alert value
126992	System time
127251	Rate of turn
127257	Attitude
127498	Engine parameters: Static
127503	AC input status (obsolete)
127504	AC output status (obsolete)
127506	DC detailed status
127507	Charger status
127509	Inverter status
128000	Nautical leeway angle

PGN	Description
128275	Distance log
129038	AIS class A position report
129039	AIS class B position report
129040	AIS class B extended position report
129044	Datum
129285	Navigation: Route, waypoint information
129794	AIS class A static and voyage related data
129798	AIS SAR aircraft position report
129799	Radio frequency/mode/power
129802	AIS safety-related broadcast message
129808	DSC call Information
129809	AIS class B "CS" static data report, part A
129810	AIS class B "CS" static data report, part B
130313	Humidity
130314	Actual pressure
130316	Temperature: Extended range
130576	Trim tab status
130577	Direction data

## NMEA 0183 Information

### Transmit

Sentence	Description
GPAPB	APB: Heading or track controller (autopilot) sentence "B"
GPBOD	BOD: Bearing (origin to destination)
GPBWC	BWC: Bearing and distance to waypoint
GPGGA	GGA: Global positioning system fix data
GPGLL	GLL: Geographic position (latitude and longitude)
GPGSA	GSA: GNSS DOP and active satellites
GPGSV	GSV: GNSS satellites in view
GPRMB	RMB: Recommended minimum navigation information
GPRMC	RMC: Recommended minimum specific GNSS data
GP RTE	RTE: Routes
GPVTG	VTG: Course over ground and ground speed
GPWPL	WPL: Waypoint location
GPXTE	XTE: Cross track error
PGRME	E: Estimated error
PGRMM	M: Map datum
PGRMZ	Z: Altitude
SDDBT	DBT: Depth below transducer
SDDPT	DPT: Depth
SDMTW	MTW: Water temperature
SDVHW	VHW: Water speed and heading

### Receive

Sentence	Description
DPT	Depth
DBT	Depth below transducer
MTW	Water temperature
VHW	Water speed and heading
WPL	Waypoint location
DSC	Digital selective calling information
DSE	Expanded digital selective calling
HDG	Heading, deviation, and variation
HDM	Heading, magnetic
MWD	Wind direction and speed
MDA	Meteorological composite
MWV	Wind speed and angle
VDM	AIS VHF data-link message

You can purchase complete information about National Marine Electronics Association (NMEA) format and sentences from [www.nmea.org](http://www.nmea.org).

### J1939 Information

The chartplotter can receive J1939 sentences. The chartplotter cannot transmit over the J1939 network.

Description	PGN	SPN
Engine percent load at current speed	61443	92
Engine speed	61444	190
Engine manifold exhaust gas temperature - right manifold	65031	2433
Engine manifold exhaust gas temperature - left manifold	65031	2434
Engine auxiliary coolant	65172	
Active diagnostic trouble codes	65226	
Vehicle distance	65248	
Water in fuel indicator	65279	
Engine wait to start lamp	65252	1081
Engine over speed test	65252	2812
Engine air shutoff command status	65252	2813
Engine alarm output command status	65252	2814
Engine total hours of operation	65253	247
Navigation-based vehicle speed	65256	517
Engine fuel temperature 1	65262	174
Engine oil temperature 1	65262	175
Engine fuel delivery pressure	65263	94
Engine oil pressure	65263	100
Engine coolant pressure	65263	109
Engine coolant temperature	65263	110
Engine coolant level	65263	111
Engine fuel rate	65266	183
Engine average fuel economy	65266	185
Engine intake manifold #1 pressure	65270	102
Battery potential / power input 1	65271	168
Transmission oil temperature	65272	177
Transmission oil pressure	65272	127
Fuel level	65276	96
Engine oil filter differential pressure	65276	969

### 物質宣言

部件名称	有毒有害物质或元素				
	铅	汞	镉	六价铬	多溴联苯 多溴二苯醚
印刷电路板组件	X	O	O	O	O
屏幕/背光	X	O	O	O	O
金属零件	X	O	O	O	O
电缆 电缆组件 连接器	X	O	O	O	O

本表格依据 SJ/T11364 的规定编制。

O: 代表此种部件的所有均质材料中所含的该种有害物质均低于 (GB/T26572) 规定的限量

X: 代表此种部件所用的均质材料中, 至少有一类材料其所含的有害物质高于

(GB/T26572) 规定的限量

\*該產品說明書應提供在環保使用期限和特殊標記的部分詳細講解產品的擔保使用條件。



### 中国微功率无线电发射设备合规

一) 工作于 2.4 GHz 频段的 ANT 技术无线遥控设备, 使用频率: 2.4 GHz, 发射功率限值: <10 mW (e.i.r.p.)(e.i.r.p), 频率容限: <170 kHz

二) 不得擅自改变使用场景或使用条件、扩大发射频率范围、加大发射功率 (包括额外加装射频功率放大器), 不得擅自更改发射天线;

三) 不得对其他合法的无线电台 (站) 产生有害干扰, 也不得提出免受有害干扰保护;

四) 应当承受辐射射频能量的工业、科学及医疗 (ISM) 应用设备的干扰或其他合法的无线电台 (站) 干扰;

五) 如对其他合法的无线电台 (站) 产生有害干扰时, 应立即停止使用, 并采取消除措施消除干扰后方可继续使用;

六) 在航空器内和依据法律法规、国家有关规定、标准划设的射电天文台、气象雷达站、卫星地球站 (含测控、测距、接收、导航站) 等军民用无线电台 (站)、机场等的电磁环境保护区域内使用微功率设备, 应当遵守电磁环境保护及相关行业主管部门的规定;

八) 微功率设备使用时温度 -15~55°C 和电压 10~32 Vdc。

### 低功率電波輻射電機管理宣告

本產品謹遵循中華民國國家通訊傳播委員會所頒布電信管理法, 並經驗證通過合格, 請使用者遵循相關電信法規以避免違反規定受罰。若使用者欲攜帶本機至其他國家應用, 也請遵循該地區或國家之相關法令限制。根據國家通訊傳播委員會低功率射頻器材技術規範規定

#### 3.8.2 章節:

取得審驗證明之低功率射頻器材, 非經核准, 公司、商號或使用者均不得擅自變更頻率、加大功率或變更原設計之特性及功能。

低功率射頻器材之使用不得影響飛航安全及干擾合法通信; 經發現有干擾現象時, 應立即停用, 並改善至無干擾時方得繼續使用。

前項合法通信, 指依電信法規定作業之無線電通信。低功率射頻器材須忍受合法通信或工業、科學及醫療用電波輻射性電機設備之干擾。

### 連絡地址

製造銷售: 台灣國際航電股份有限公司

聯絡地址: 新北市汐止區樟樹二路 68 號

電話: (02)2642-8999

客服專線: (02)2642-9199

© 2020 Garmin Ltd. or its subsidiaries

Garmin®, the Garmin logo, and GPSMAP® are trademarks of Garmin Ltd. or its subsidiaries, registered in the USA and other countries. These trademarks may not be used without the express permission of Garmin.

NMEA®, NMEA 2000®, and the NMEA 2000 logo are registered trademarks of the National Marine Electronics Association. HDMI® is a registered trademark of HDMI Licensing, LLC. The SDHC logo is a trademark of SD-3C, LLC. Wi-Fi® is a registered trademark of Wi-Fi Alliance Corporation.

GPSMAP 1223/1243/1253/1223xsv/1243xsv/1253xsv, GPSMAP 723/743/753/723xsv/743xsv/753xsv, GPSMAP 923/943/953/923xsv/943xsv/953xsvn

M/N: A0387, B03873, A03875 FCC: IPH-03873, IPH-03875 IC: 1792A-03873, 1792A-03875 Garmin Corporation