

Technical Reference

for Garmin®

NMEA 2000® Products

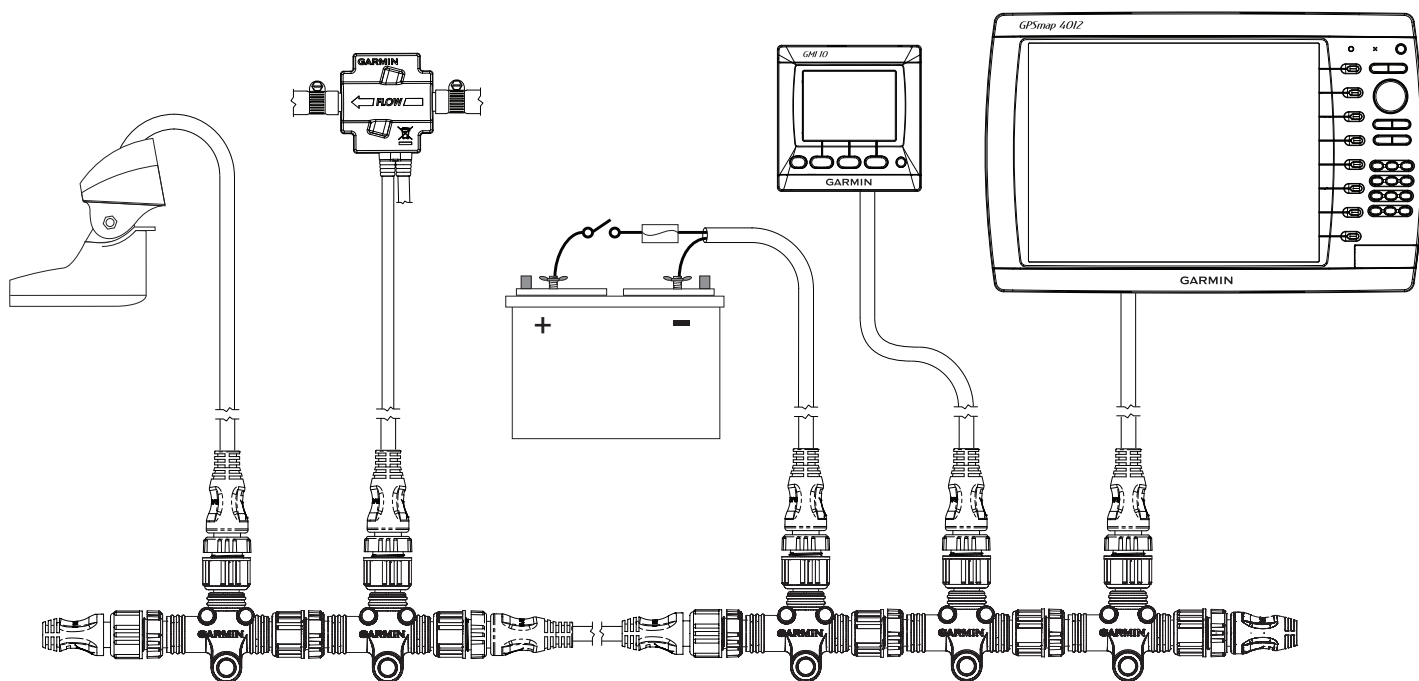

All rights reserved. Except as expressly provided herein, no part of this manual may be reproduced, copied, transmitted, disseminated, downloaded or stored in any storage medium, for any purpose without the express prior written consent of Garmin. Garmin hereby grants permission to download a single copy of this manual onto a hard drive or other electronic storage medium to be viewed and to print one copy of this manual or of any revision hereto, provided that such electronic or printed copy of this manual must contain the complete text of this copyright notice and provided further that any unauthorized commercial distribution of this manual or any revision hereto is strictly prohibited.

Information in this document is subject to change without notice. Garmin reserves the right to change or improve its products and to make changes in the content without obligation to notify any person or organization of such changes or improvements. Visit the Garmin Web site (www.garmin.com) for current updates and supplemental information concerning the use and operation of this and other Garmin products.

Garmin®, the Garmin logo, and GPSMAP® are trademarks of Garmin Ltd. or its subsidiaries, registered in the USA and other countries. GFST™, GWS™, GHP™, GXM™, GFL™, GBT™, GST™, GMI™, GRA™, GET™, GHC™, Intelliducer™, are trademarks of Garmin Ltd. or its subsidiaries. These trademarks may not be used without the express permission of Garmin.

NMEA 2000® and the NMEA 2000 logo are registered trademarks of the National Maritime Electronics Association.

Introduction

A NMEA 2000 network consists of connected NMEA 2000 devices that communicate using basic plug-and-play functionality. This technical reference provides basic NMEA 2000 component identification, basic NMEA 2000 network-building instructions, and a list of NMEA 2000-specific data used with Garmin NMEA 2000-certified displays and sensors.

- The first section, NMEA 2000 Fundamentals, provides descriptions of the NMEA 2000 connectors and cables sold by Garmin, and the fundamental concepts of installing a NMEA 2000 network on your boat.
- The second section, General NMEA 2000 Data Type Requirements, provides a table to help you determine which NMEA 2000 sensors provide the particular data type you want.
- The last two sections provide Parameter Group Number (PGN) information for Garmin chartplotters and marine instruments as well as configuration and PGN information for Garmin NMEA 2000 sensors. These sections contain PGN and configuration information for the following products:
 - GPSMAP® 4000/5000/6000/7000 Series chartplotters
 - GPSMAP 700 Series chartplotters
 - GPSMAP 4x1/5x1/5x6 Series chartplotters
 - GMI™ 10
 - GPS 17x
 - GFS™ 10
 - GRA™ 10
 - GET™ 10
 - GFL™ 10
 - GBT™ 10
 - GST™ 10
 - Intelliducers™
 - GWS™ 10
 - GHP™ 10 (CCU and GHC™ 10)
 - GXM™ 51
 - VHF 200/300
 - AIS 300
 - AIS 600

 **NOTE:** PGN information is also included in the installation instructions provided with the Garmin NMEA 2000-certified device. Sensor configuration information is also included in a *Sensor Configuration Guide* provided with each Garmin NMEA 2000-certified sensor.

- At the end is a checklist. Use this checklist when installing a NMEA 2000 network to be sure you have correctly followed installation-critical procedures.

Contact Garmin

If you experience difficulty installing a NMEA 2000 network, or have other questions about NMEA 2000-certified Garmin devices, contact Garmin Product Support or a certified NMEA 2000 technician. In the USA, go to www.garmin.com/support, or contact Garmin USA by phone at (913) 397-8200 or (800) 800-1020.

In the UK, contact Garmin (Europe) Ltd. by phone at 0808 2380000.

In Europe, go to www.garmin.com/support and click **Contact Support** for in-country support information, or contact Garmin (Europe) Ltd. by phone at +44 (0) 870.8501241.

Table of Contents

Introduction	iii
Contact Garmin.....	iii
NMEA 2000 Fundamentals	1
Garmin NMEA 2000 Device Overview.....	1
Building a NMEA 2000 Network.....	3
Existing NMEA 2000 Installation Considerations.....	8
NMEA 2000 Glossary.....	8
General NMEA 2000 Data Type Requirements	9
NMEA 2000-Certified Display Device PGN Information	13
NMEA 2000-Certified Sensor PGN Information	18
GPS 17x (GPS Antenna).....	18
GFS 10 (Garmin Fuel Sensor).....	18
GRA 10 (Garmin Rudder Angle Adapter).....	18
GET 10 (Garmin Engine Tilt Adapter).....	18
GFL 10 (Garmin Fluid Level Adapter).....	19
GBT 10 (Garmin Bennett Trim Tab Adapter).....	19
GST 10 (Garmin Water Speed and Temperature Adapter).....	19
Intelliducer (Intelligent Depth Transducer–Transom Mount and Thru-Hull).....	19
GWS 10 (Garmin Wind Sensor).....	20
GHP 10 (Marine Autopilot System).....	20
GXM 51.....	21
VHF 200.....	21
VHF 300.....	21
AIS 300.....	22
AIS 600.....	22
NMEA 2000-Certified Sensor Configuration Information	23
GPS 17x (GPS Antenna).....	23
GFS 10 (Garmin Fuel Sensor).....	24
GRA 10 (Garmin Rudder Angle Adapter).....	26
GET 10 (Garmin Engine Tilt Adapter).....	27
GFL 10 (Garmin Fluid Level Adapter).....	29
Restoring Factory Default Settings.....	32
GBT 10 (Garmin Bennett Trim Tab Adapter).....	32
GST 10 (Garmin Water Speed and Temperature Adapter).....	33
Restoring Factory Default Settings.....	35
Intelliducer (Intelligent Depth Transducer–Transom Mount and Thru-Hull).....	36
GWS 10 (Garmin Wind Sensor).....	36
NMEA 2000 Checklist.....	37

NMEA 2000 Fundamentals

A NMEA 2000 network is made of connected NMEA 2000 devices that communicate using basic plug-and-play functionality.

If your boat already contains a NMEA 2000 network and you would like to add Garmin NMEA 2000 components, see [page 8](#).

For a glossary of commonly used NMEA 2000 terms, see [page 8](#).

After you have installed your NMEA 2000 network, use the checklist on [page 37](#) to verify the installation.

Garmin NMEA 2000 Device Overview

Garmin uses NMEA 2000 micro connectors on units, sensors, and T-connectors that are compatible with other NMEA 2000 micro connectors, cables, and NMEA 2000-compatible devices. Garmin sensors may be packaged with a drop cable and a T-connector. Garmin displays may also include additional NMEA 2000 components (such as a power cable). The NMEA 2000 components included with a Garmin sensor or display are listed in the product documentation. A diagram on the product box shows which NMEA 2000 components are included.

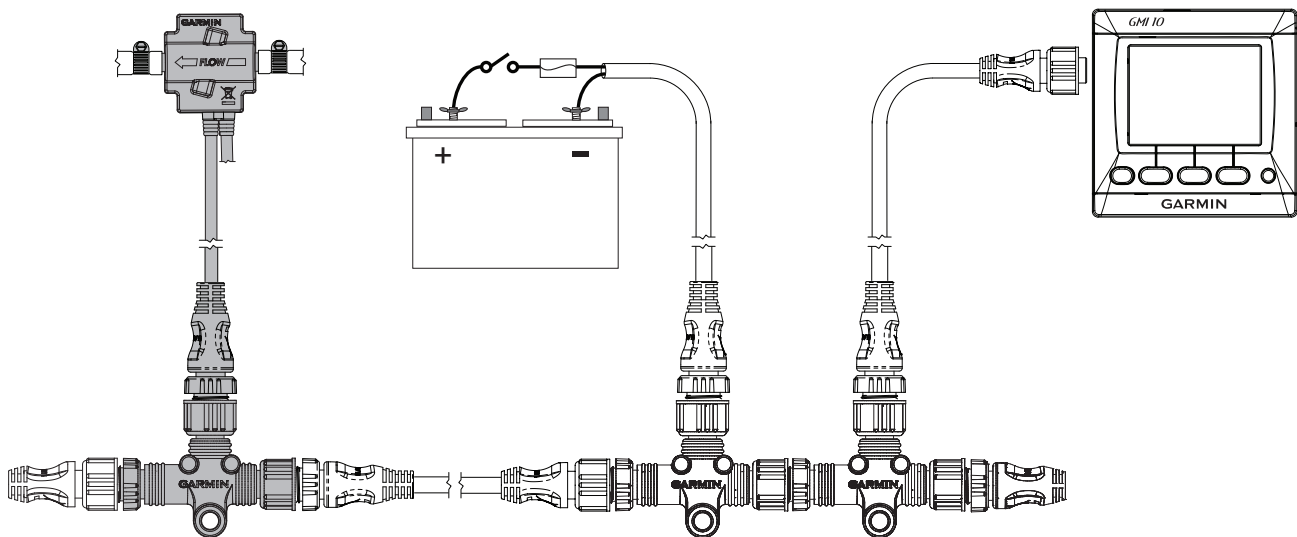

Sample Box Diagram (GFS 10)

In the sample box diagram, a complete NMEA 2000 network is shown, and the parts included with the sensor are shaded. In this example, a T-connector is included with a Garmin GFS 10 fuel sensor. A NMEA 2000 power cable, terminators, an additional drop/backbone cable, and additional T-connectors are not included with a GFS 10 fuel sensor. The GFS 10 fuel sensor, as shown by the shaded components in the box diagram, is intended to be connected to an existing NMEA 2000 network on your boat. If you do not have a NMEA 2000 network on your boat, this guide will help you assemble one.

NMEA 2000 Components

The main components of a NMEA 2000 network are T-connectors, terminators, backbone/drop cables, and a power cable. The following cables, connectors, and terminators are sold by Garmin, and as of January 2009, they are NMEA 2000 approved. NMEA 2000-approved cables sold by Garmin feature the NMEA 2000 logo on the tag with the part number.

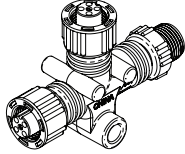
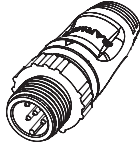
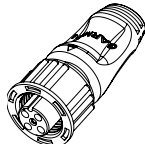
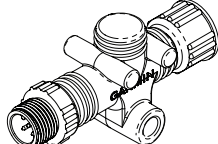
T-connector	Male Terminator	Female Terminator	In-line Terminator
			
010-11078-00 (Garmin part number)	010-11080-00	010-11081-00	010-11096-00

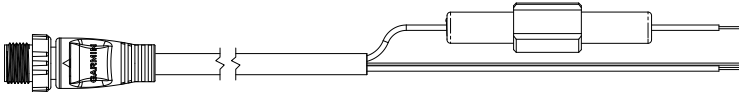
Power Cable

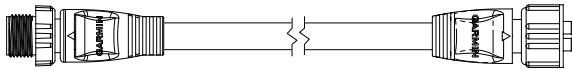
010-11079-00 (2 meters [6.5 feet]) (3 A fuse included)

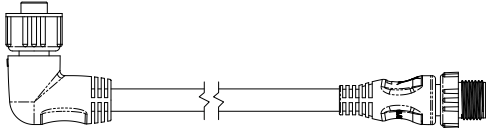
Backbone/Drop Cable	
	
305 millimeters (1 foot)	010-11076-03
2 meters (6.5 feet)	010-11076-00
6 meters (20 feet)	010-11076-01
10 meters (33 feet) (backbone only)	010-11076-02
30 meter spool (98.5 feet) (backbone only)	010-11171-01

Specialty Cable/Connectors	
	
Right-angle drop-cable, 2 meters (6.5 feet) (pictured)	010-11089-00
Field-installable connector - Male* (not pictured)	010-11094-00
Field-installable connector - Female* (not pictured)	010-11095-00
NMEA 2000 network power switch (not pictured)	K00-00368-00
NMEA 2000 in-line lightning arrester** (not pictured)	010-11171-02

* The field-installable connectors are used to create custom-length drop cables and custom-length backbone extension cables. The field-installable connectors can be used to shorten any Garmin NMEA 2000 drop/backbone cable.

** The gray in-line lightning arrester is designed to help prevent damage due to nearby lightning strikes, but it is not able to protect against direct lightning strikes. Garmin is not responsible for lightning-strike related damage.

 **NOTE:** All male/female connections are interchangeable. Ensure that the T-connectors are used properly when constructing your NMEA 2000 network. See [page 4](#).

Building a NMEA 2000 Network

The main communication channel of a NMEA 2000 network is a backbone to which your NMEA 2000 devices connect. Each NMEA 2000 device connects to the backbone with a T-connector. The NMEA 2000 backbone must be connected to power, and terminators must be installed at both ends for the network to function correctly.

When you design a NMEA 2000 network, start by creating a diagram of the network. When creating the diagram, be as detailed as possible:

- Include all of the devices you intend to connect to your network
- Note the approximate location of the backbone and devices on your boat
- Measure the distances between devices and the backbone, as well as the overall length of the backbone
- Note the power consumption of each device (Load Equivalency Number)

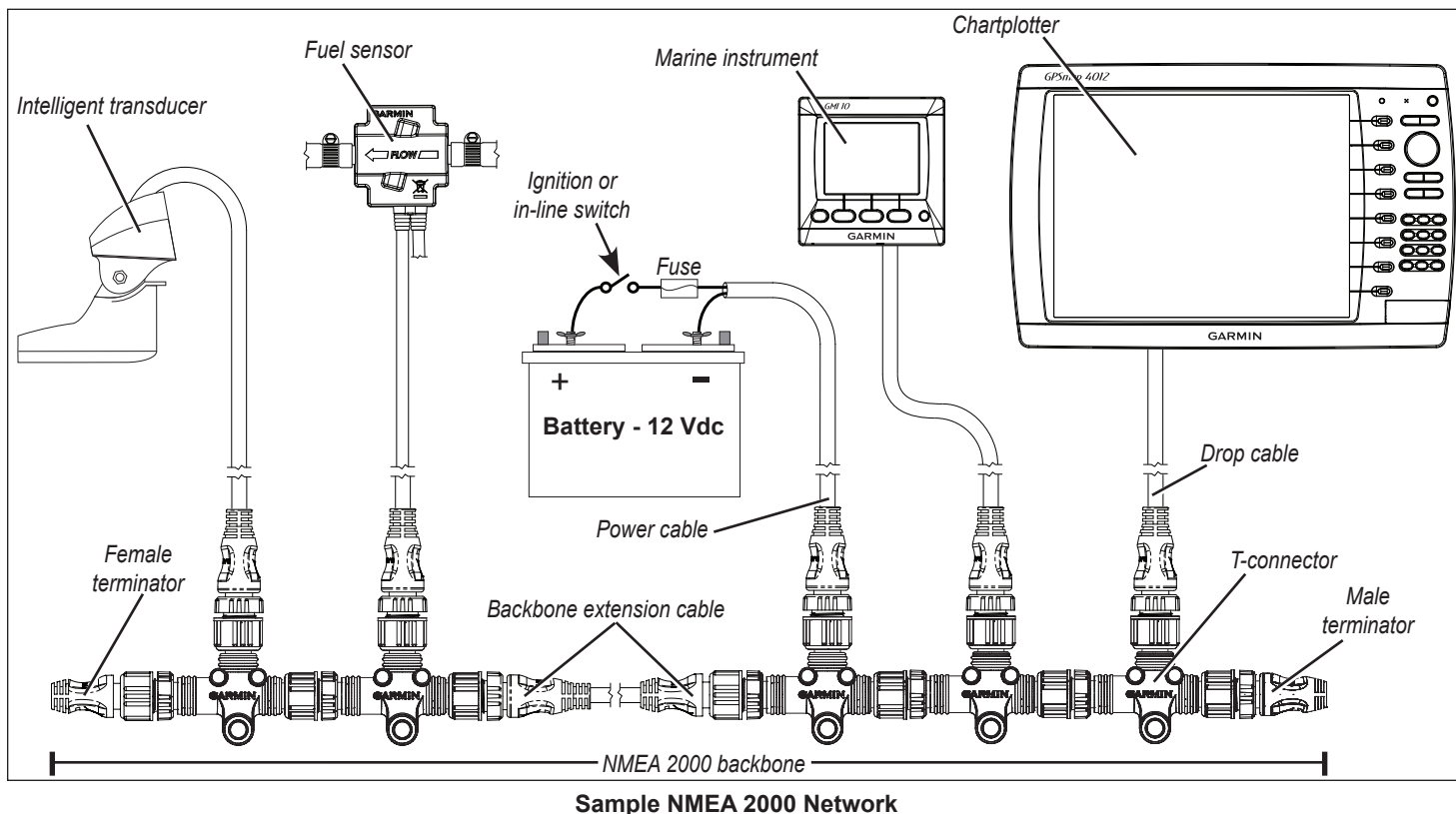

NOTE: This diagram illustrates the NMEA 2000 data connections to each device or sensor. Some devices or sensors can be powered by the NMEA 2000 network; others may require a separate power connection. Consult the installation instructions for each device you connect to your NMEA 2000 network to be sure you supply power to the device appropriately.

When building a NMEA 2000 network, you must follow certain rules to make sure your NMEA 2000 network functions correctly. Be sure to understand the following concepts:

- Linear backbone construction ([page 4](#))
- Power connection and distribution ([page 5](#))
- Proper termination ([page 7](#))
- Cable length and device limits ([page 8](#))

Linear Backbone Construction

Use the NMEA 2000 T-connectors to construct your NMEA 2000 backbone, and extend the backbone with appropriate lengths of backbone cable if necessary. Use one T-connector per device. Use the sides of the T-connector to construct the backbone of the NMEA 2000 network, and use the top of the T-connector to attach a NMEA 2000 device. By using only the sides of the T-connectors to construct the backbone, you create a linear construction to your NMEA 2000 network. T-connectors can be separated by backbone cables or connected directly together.

Although the male and female connectors on the T-connectors and backbone cables will fit on all sides of a T-connector, it is very important to use the top of the T-connector only to attach NMEA 2000 devices, not to attach other T-connectors or backbone cables.

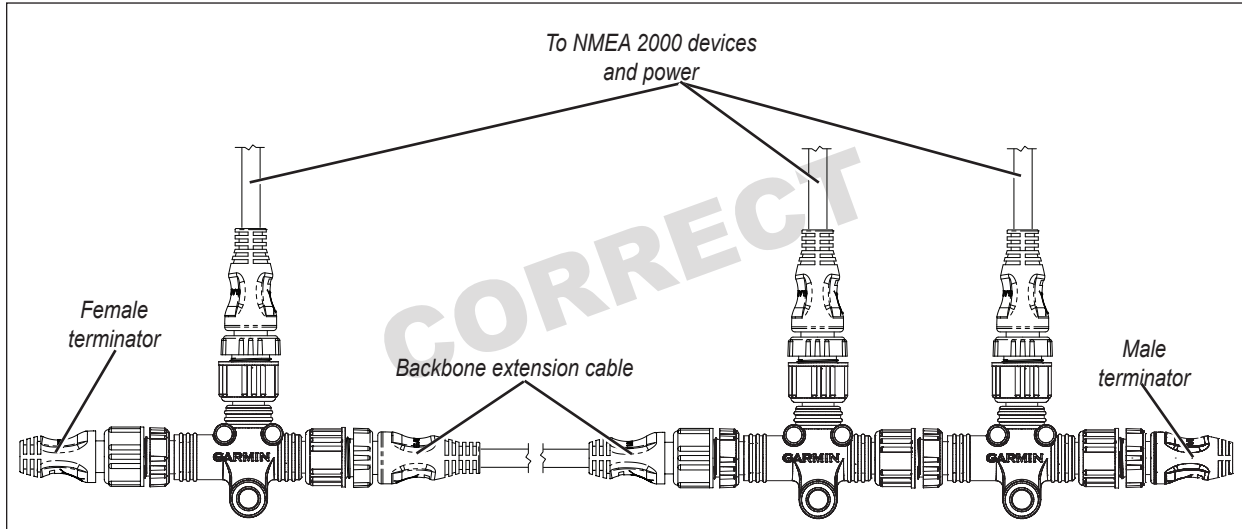

Correct Linear Backbone Construction

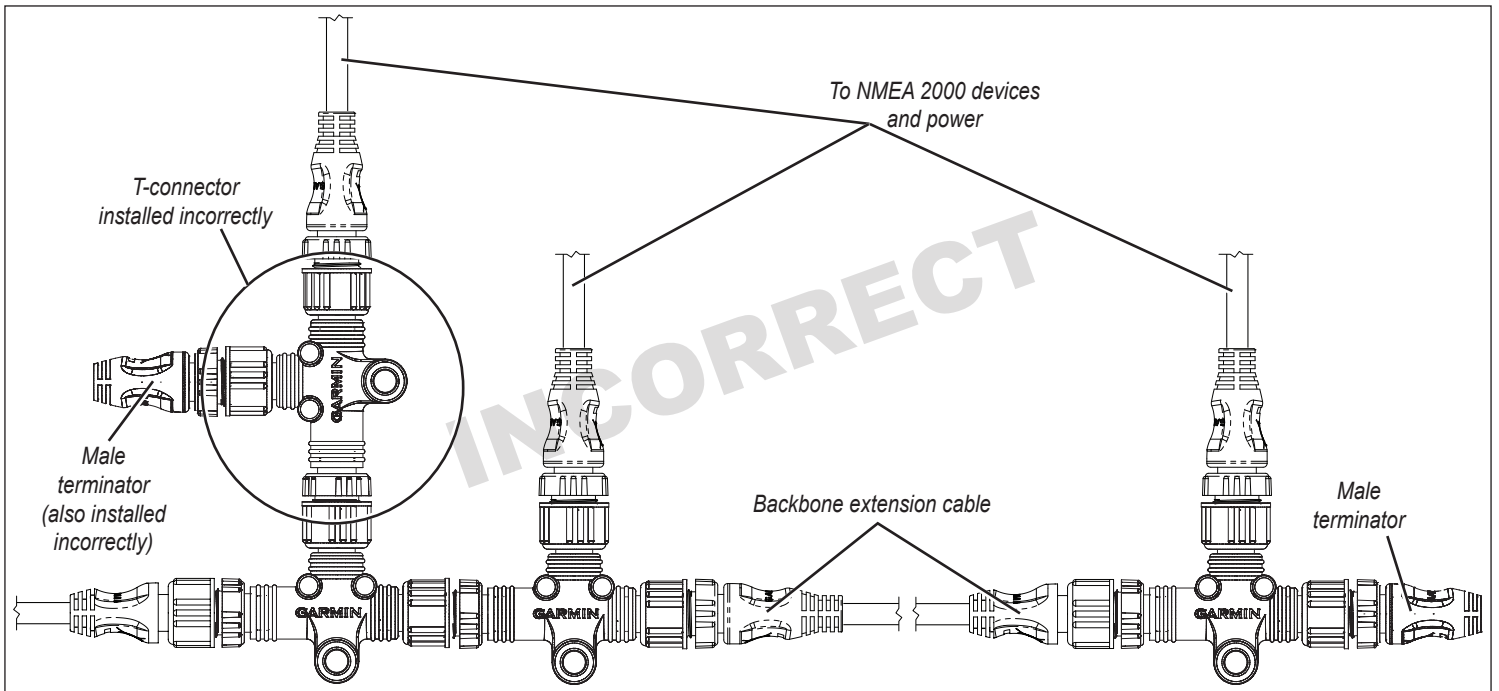

Incorrect Linear Backbone Construction

Power Connection and Distribution

Your NMEA 2000 network must be connected to a 12 Vdc power supply. Do not connect your NMEA 2000 network to any other voltage source, such as a 24 Vdc power supply. Use a NMEA 2000 power cable to connect your NMEA 2000 backbone to the auxiliary power switch on your boat. If you do not have an auxiliary power switch, or if connecting to the auxiliary power switch causes electrical interference, connect the NMEA 2000 power cable directly to the battery and install an in-line switch.

CAUTION: If you connect the NMEA 2000 network to your battery without an in-line switch, it may drain your battery.

Be sure to ground the NMEA 2000 power cable. Connect the bare shield-drain wire to the same location as the ground (black) wire.

The Garmin NMEA 2000 power cable connects to a T-connector like other drop cables. Be sure to connect the NMEA 2000 power cable to the top of a T-connector; never connect the NMEA 2000 power cable to the side of a T-connector. You can connect power either at the end of your NMEA 2000 network or in the middle. When planning where to place the power cable and the T-connector on your NMEA 2000 network, you will need to evaluate how the NMEA 2000 devices connected to your network use power. The NMEA 2000 network will work properly when there is no more than a 3 Vdc drop in the supply voltage between the power source and the NMEA 2000 device located farthest from the power source on the NMEA 2000 network. To determine the voltage drop in your NMEA 2000 network, use this equation:

$$\text{Voltage Drop} = \text{Cable resistance (ohms/m)}^* \times \text{Distance (from the battery to the farthest device, in meters)} \times \text{Network Load}^{**} \times 0.1$$

* Garmin cable resistance value = 0.053

** Network Load = the sum of Load Equivalent Numbers (LEN) between the battery and the end of the network. The LEN for each device should be visible on the device, or provided in the documentation for the device.

- If you calculate a voltage drop of 3.0 Vdc or less, then you can connect power to either the end or the middle of your NMEA 2000 network, and it will function correctly.
- If you calculate a voltage drop of more than 3.0 Vdc, you must connect power to the middle of your NMEA 2000 network. The location will depend on the network load and distance from the battery. Try to balance the voltage drop equally on both sides of the power connection.
- If a voltage drop of under 3.0 Vdc is not possible on your NMEA 2000 network, contact a professional installer.

Examples

The following examples show a correctly designed, end-powered NMEA 2000 network; an incorrectly designed NMEA 2000 network; and a redesign of the incorrectly designed NMEA 2000 network to correctly balance power on the network.

End-powered NMEA 2000 network, correctly designed:

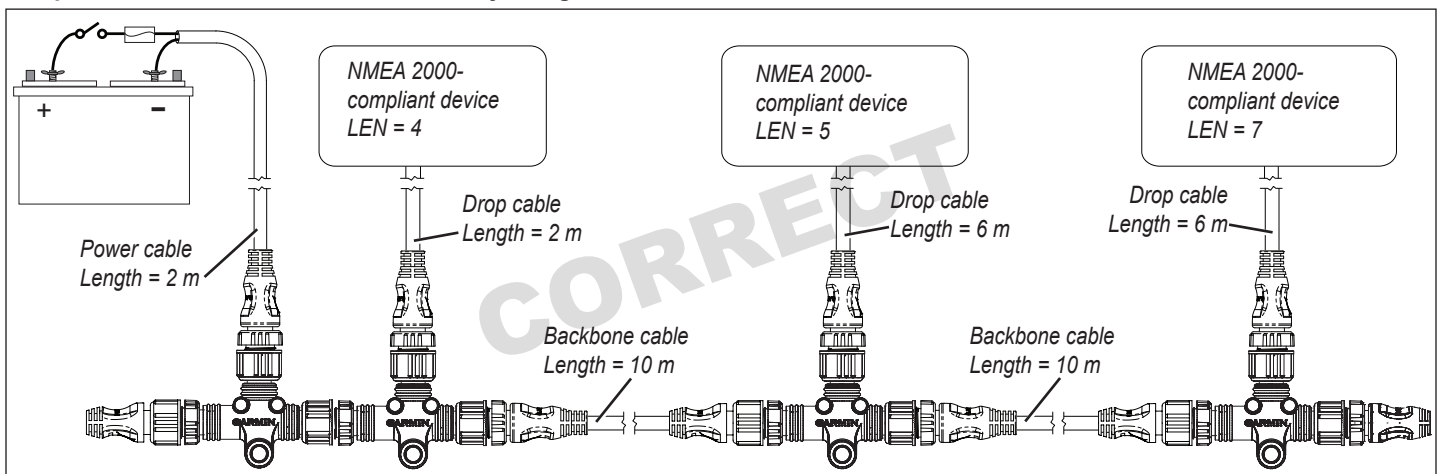

When the voltage-drop formula is applied to this example, we see that the voltage drop is less than 3.0 Vdc. This NMEA 2000 network will function correctly when powered at the end.

$$\text{Voltage Drop} = 0.053 \times (2 + 10 + 10 + 6) \times (4 + 5 + 7) \times 0.1 = 2.37 \text{ Vdc}$$

Cable resistance
Distance
Network load

End-powered NMEA 2000 network, incorrectly designed:

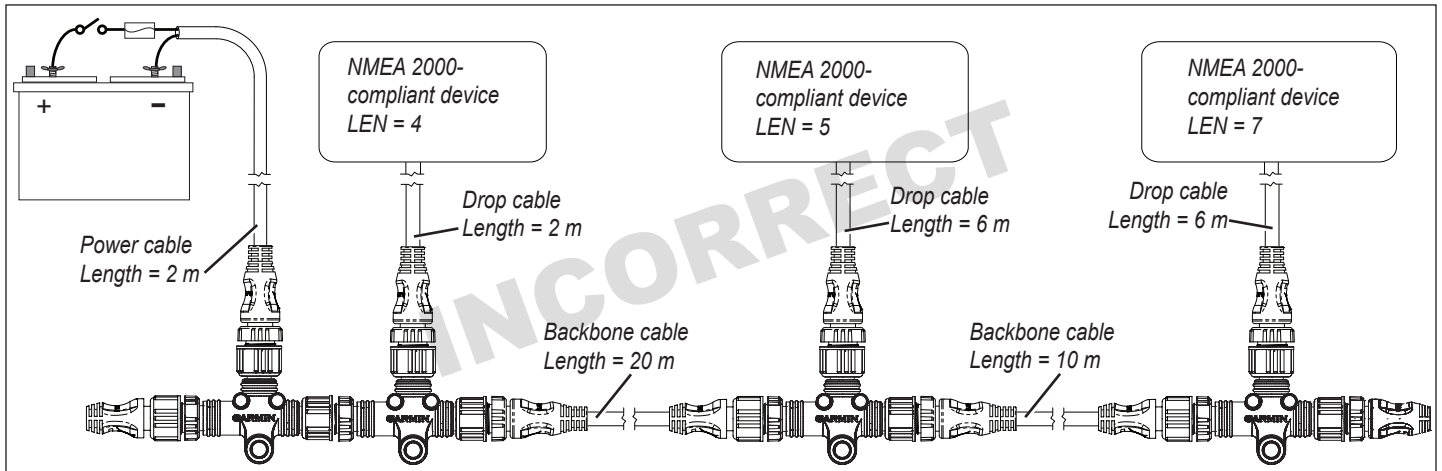

When the voltage drop formula is applied to this example, we see that the voltage drop is greater than 3.0 Vdc, so this NMEA 2000 network will not function correctly when powered at the end.

$$\text{Voltage Drop} = 0.053 \times (2 + 20 + 10 + 6) \times (4 + 5 + 7) \times 0.1 = 3.22 \text{ Vdc}$$

Cable resistance
Distance
Network load

This NMEA 2000 network must be redesigned with the power connected to the center of the network in order to function correctly.

Middle-powered NMEA 2000 network, correctly designed:

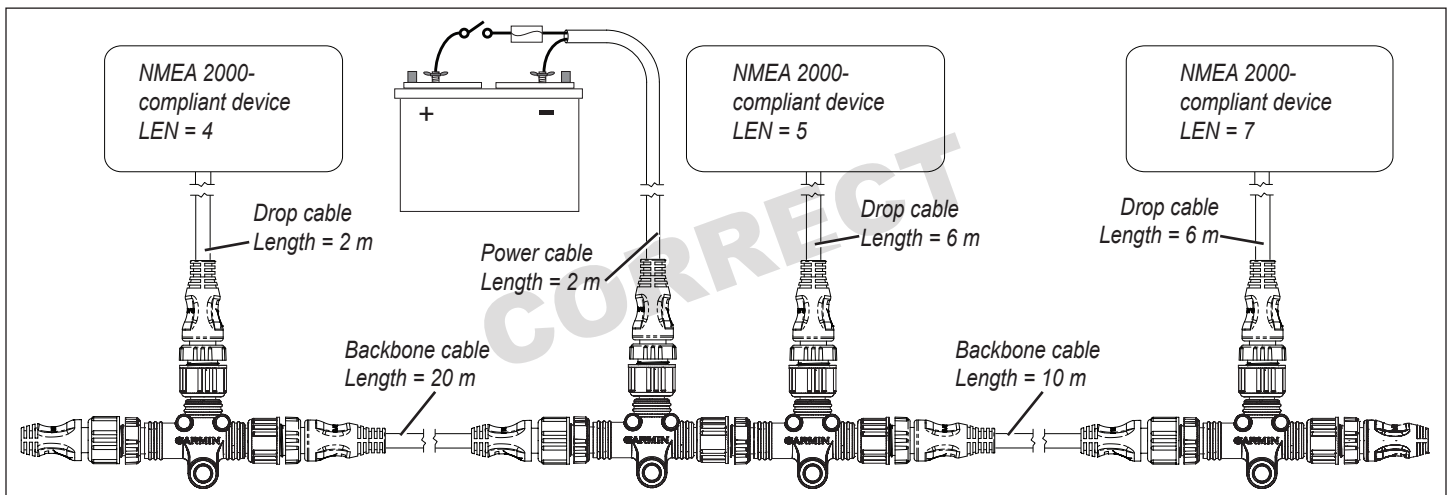

When the NMEA 2000 network is redesigned with the power source in the center, you calculate the voltage drop in both directions. If the T-connector to which you connect the power source is connected directly to another T-connector (as shown in this example), use the LEN from that device as part of the calculation for both directions.

When the voltage drop formula is applied to both the left and right sides of the power source in this example, we see that the voltage drop is less than 3.0 Vdc on each side, so the NMEA 2000 network will function correctly.

$$\text{Voltage Drop Left} = 0.053 \times (2 + 20 + 2) \times (4 + 5) \times 0.1 = 1.145 \text{ Vdc}$$

Cable resistance
Distance
Network load

$$\text{Voltage Drop Right} = 0.053 \times (2 + 10 + 6) \times (5 + 7) \times 0.1 = 1.145 \text{ Vdc}$$

NOTE: The equation and examples provide conservative estimates for calculating voltage drop.

Proper Termination

You must install terminators at the ends of your NMEA 2000 backbone for it to function correctly. You have two options when installing terminators on your NMEA 2000 network.

1. Typical Terminators

If your NMEA 2000 network is built with correct linear backbone construction, use one female terminator and one male terminator. Install the terminators at opposite ends of your NMEA 2000 network.

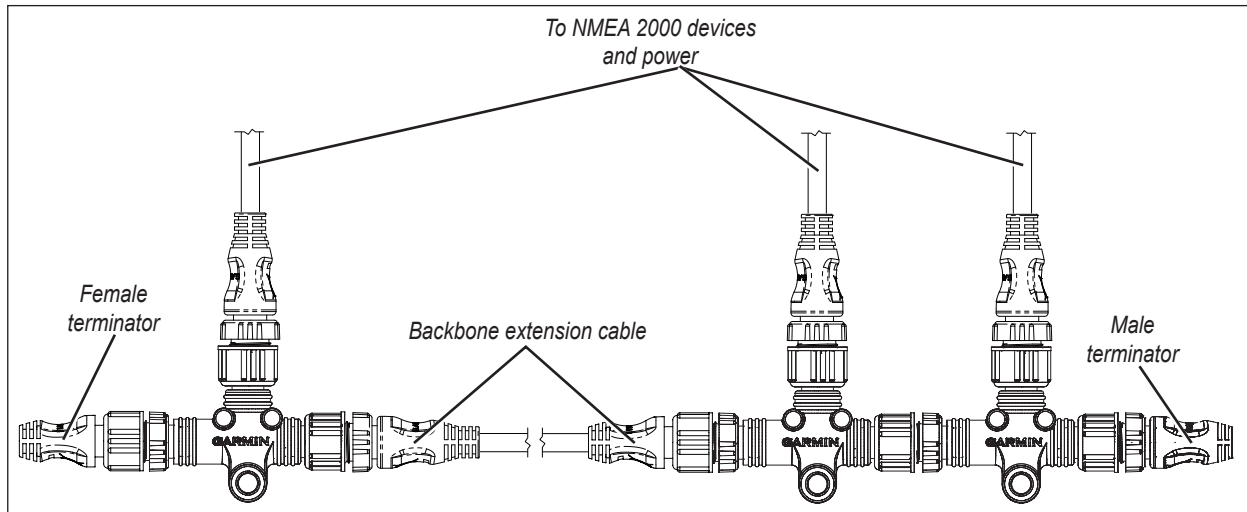

Using Standard Terminators

2. In-line Terminators

If one or both of the NMEA 2000 devices at opposite ends of your NMEA 2000 network are separated from the rest of the NMEA 2000 network by a length of backbone cable, and the typical T-connector/drop cable/terminator combination is not feasible or is too bulky for the area, use an in-line terminator instead of the final T-connector on the backbone. Connect the final device to the in-line terminator with the appropriate length of drop cable, or connect the final device directly to the in-line terminator, without a drop cable.

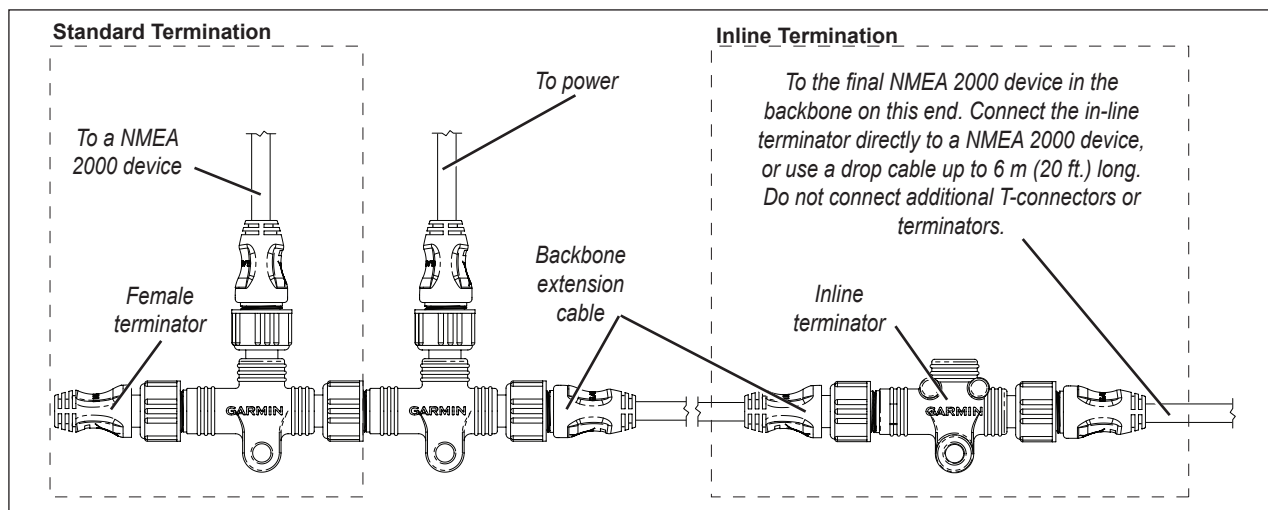

Using an Inline Terminator

CAUTION: Do not use more than two terminators in a NMEA 2000 network.

NOTE: The in-line terminator connects to the NMEA 2000 backbone with a male connector, and to the final NMEA 2000 device with a female connector. Because of this, you can only use one in-line terminator on a NMEA 2000 network.

Cable Length and Device Limits

When building your NMEA 2000 network, keep in mind these limitations:

- The distance between any two points on the NMEA 2000 network must not exceed 100 m (328 ft). To estimate this distance, measure between the terminators on your backbone and add the length of the drop cable for the devices connected to the T-connectors at the ends of the network.
- The total length of all drop cables cannot exceed 78 m (256 ft).
- The maximum length of a single drop cable to a NMEA 2000 device is 6 m (20 ft).
- No more than 50 NMEA 2000 devices can be connected to your NMEA 2000 network.

Existing NMEA 2000 Installation Considerations

If your boat has an existing NMEA 2000 installation, and you would like to add Garmin NMEA 2000 equipment, there are a few things to consider:

Cable Type: Garmin uses NMEA 2000 micro connectors for all cables and connectors. Your existing NMEA 2000 network may use NMEA 2000 mini connectors and cables in the backbone. Mini connectors are larger than micro connectors, and you will need to use a converter or adapter to connect with Garmin NMEA 2000 devices.

Power: Is the existing NMEA 2000 network connected to power? A NMEA 2000 network must be connected to power to function correctly ([page 5](#)). Do not connect the NMEA 2000 network to power at more than one location.

Termination: Are terminators installed on the ends of the existing NMEA 2000 backbone? A NMEA 2000 network must be terminated to function correctly. Do not add more terminators to a NMEA 2000 network if it is already properly terminated.

If you are unsure of any of these considerations, contact your boat manufacturer or a certified NMEA 2000 technician for assistance.

NMEA 2000 Glossary

T-connector—Three-way connector with one male and two female micro connectors. A T-connector is used to connect a NMEA 2000 device to the NMEA 2000 backbone.

Terminator—120 ohm resistor located at each end of the NMEA 2000 backbone. Proper termination helps ensure signal integrity across the entire length of the backbone.

Inline Terminator—Special terminator with male and female connectors, which allows direct connection to the a device at the end of the NMEA 2000 backbone. The inline terminator simplifies installation by not requiring a T-connector, terminator, and drop cable for the device at the end of the backbone.

Drop Cable—Cable connecting a NMEA 2000 device to the NMEA 2000 backbone. Drop cables are limited to 6 m (20 ft.) maximum length.

Backbone Cable—In conjunction with T-connectors, the backbone cables create the main communication path of the NMEA 2000 network. A backbone cable extends the NMEA 2000 backbone to connect NMEA 2000 devices located in different places on the boat. The maximum backbone cable length is 100 m (328 ft.).

Device—Electronic hardware that connects to the NMEA 2000 network. A device may only receive data transmitted by other devices on the network, or may both transmit and receive data on the network.

Network Power—12 Vdc power supplied to the NMEA 2000 network. Power should be connected through a switch (instead of directly connected to the battery) because some devices are always on when NMEA 2000 power is present. NMEA 2000 devices must operate from 9 to 16 Vdc, with a nominal voltage of 12 Vdc.

LEN (Load Equivalency Number)—A number that indicates the amount of current a device draws from the NMEA 2000 network. 1 LEN = 50 mA. Each device should have an LEN specified on the product or in the product documentation.

General NMEA 2000 Data Type Requirements

Each NMEA 2000-certified sensor provides unique information to the NMEA 2000-certified display devices (such as a GPSMAP 4000/5000 series chartplotter or a GMI 10) on the NMEA 2000 network. The data you can view on your display device depends on the sensors you have installed and configured. Refer to the following table for a list of data types that you can view on a display device; specific NMEA 2000 PGN information required to view or calculate that data type; and the NMEA 2000 sensor that typically provides required PGN information. In some cases, more than one sensor is necessary or a specific combination of sensors may provide more-precise information. For more about PGN information, see [page 18](#).

Category	Data Type	PGN Data Required	Typical Sender
Engine Information	Battery Voltage	127489 - Eng Dynamic	NMEA 2000-compatible engine
	Fuel Flow Rate	127489 - Eng Dynamic	Fuel Flow Sensor
	Hours	127489 - Eng Dynamic	NMEA 2000-compatible engine
	Oil Pressure	127489 - Eng Dynamic	NMEA 2000-compatible engine
	Engine RPM	127488 - Engine Rapid	NMEA 2000-compatible engine
	Temperature	127489 - Eng Dynamic	NMEA 2000-compatible engine
	Coolant Pressure	127489 - Eng Dynamic	NMEA 2000-compatible engine
	Fuel Pressure	127489 - Eng Dynamic	NMEA 2000-compatible engine
	Oil Temperature	127489 - Eng Dynamic	NMEA 2000-compatible engine
	Boost Pressure	127488 - Engine Rapid	NMEA 2000-compatible engine
	Trim	127488 - Engine Rapid	NMEA 2000-compatible engine
	Rudder Angle	127245 - Rudder	Rudder Angle Sensor
	Bow Tabs	130576 - Small Craft Status	Trim Tab Sensor
Trim Tabs	130576 - Small Craft Status	Trim Tab Sensor	
Fuel Information	Total Fuel Flow Rate	127489 - Eng Dynamic	Fuel Flow Sensor
	Total Fuel Onboard	127489 - Eng Dynamic	Fuel Flow Sensor
	Fuel Economy	127489 - Eng Dynamic (GPS Speed or Water Speed) Note: The Fuel Economy data type is configurable, based on the fuel speed source	Fuel Flow Sensor and Speed Sensor
	Cruising Range	127489 - Eng Dynamic (GPS Speed or Water Speed)	Fuel Flow Sensor and Speed Sensor
	Fuel Level	127505 - Fluid Level	Fuel Level Sensor
	Tank 1	127505 - Fluid Level	Fuel Level Sensor
	Tank 2	127505 - Fluid Level	Fuel Level Sensor
Navigation Information	Course Made Good	129026 - COG/SOG, 129029 - GNSS Position, 129284 - Nav Data, 129285 - Route, and 129283 - XTE	Garmin Chartplotter and GPS Antenna
	Distance Made Good	129026 - COG/SOG, 129029 - GNSS Position, 129284 - Nav Data, and 129285 - Route	Garmin Chartplotter and GPS Antenna
	Waypoint Name	129284 - Nav Data or 129285 - Route	Garmin Chartplotter
	Bearing to Waypoint	129284 - Nav Data	Garmin Chartplotter and GPS Antenna
	Distance to Waypoint	129284 - Nav Data	Garmin Chartplotter and GPS Antenna
	Off Course	129283 - XTE	Garmin Chartplotter and GPS Antenna
	Desired COG	129284 - Nav Data	Garmin Chartplotter and GPS Antenna
	Heading	127250 - Vessel Heading	Heading Sensor
Course Over Ground	129026 - COG/SOG and 129029 - GNSS Position	GPS Antenna	

(Continued)

General NMEA 2000 Data Type Requirements

Category	Data Type	PGN Data Required	Typical Sender
Navigation Information (continued)	GPS Speed	129026 - COG/SOG and 129029 - GNSS Position	GPS Antenna
	Position	129026 - COG/SOG and 129029 - GNSS Position	GPS Antenna
	Turn	129026 - COG/SOG, 129029 - GNSS Position, and 129284 - Nav Data	Garmin Chartplotter and GPS Antenna
Trip	Odometer	129026 - COG/SOG and 129029 - GNSS Position	GPS Antenna
	Trip Odometer	129026 - COG/SOG and 129029 - GNSS Position	GPS Antenna
	Average GPS Speed	129026 - COG/SOG and 129029 - GNSS Position	GPS Antenna
	Maximum GPS Speed	129026 - COG/SOG and 129029 - GNSS Position	GPS Antenna
	Water Odometer	128259 - Water Speed	Water Speed Sensor
	Water Trip Odometer	128259 - Water Speed	Water Speed Sensor
	Average Water Speed	128259 - Water Speed	Water Speed Sensor
	Maximum Water Speed	128259 - Water Speed	Water Speed Sensor
Weather	Barometer	130314 - Actual Pressure, 130310 - Envir Param Old, or 130311 - Envir Param	Barometric Pressure Sensor
	Air Temperature	130312 - Temp, 130310 - Envir Param Old, or 130311 - Envir Param	Air Temperature Sensor
	Humidity	130313 - Humidity or 130311 - Envir Param	Humidity Sensor
	Wind Speed	130306 - Wind Data, 129026 - COG/SOG, 129029 - GNSS Position, 127250 - Vessel Heading, and 128259 - Water Speed <i>(If a Heading Sensor and Water Speed Sensor are not present, a less-accurate reading can be calculated using only the Wind Sensor and GPS antenna [130306 - Wind Data, 129026 - COG/SOG and 129029 - GNSS Position])</i> <i>(If a GPS antenna is not present, a less-accurate reading can be calculated using only the Wind Sensor, Water Speed Sensor, and Heading Sensor [130306 - Wind Data, 127250 - Vessel Heading, and 128259 - Water Speed])</i>	Either: <ul style="list-style-type: none"> • Wind Sensor, a Water Speed Sensor, a Heading Sensor, and a GPS Antenna • Wind Sensor and a GPS Antenna • Wind Sensor, a Water Speed Sensor, and a Heading Sensor
	Wind Direction	130306 - Wind Data, 129026 - COG/SOG, 129029 - GNSS Position, 127250 - Vessel Heading, and 128259 - Water Speed <i>(If a Heading Sensor and Water Speed Sensor are not present, a less-accurate reading can be calculated using only the Wind Sensor and GPS antenna [130306 - Wind Data, 129026 - COG/SOG and 129029 - GNSS Position])</i> <i>(If a GPS antenna is not present, a less-accurate reading can be calculated using only the Wind Sensor, Water Speed Sensor, and Heading Sensor [130306 - Wind Data, 127250 - Vessel Heading, and 128259 - Water Speed])</i>	Either: <ul style="list-style-type: none"> • Wind Sensor, a Water Speed Sensor, a Heading Sensor, and a GPS Antenna • Wind Sensor and a GPS Antenna • Wind Sensor, a Water Speed Sensor, and a Heading Sensor

(Continued)

Category	Data Type	PGN Data Required	Typical Sender
	Cardinal Wind Direction	130306 - Wind Data, 129026 - COG/SOG, 129029 - GNSS Position, 127250 - Vessel Heading, and 128259 - Water Speed <i>(If a Heading Sensor and Water Speed Sensor are not present, a less-accurate reading can be calculated using only the Wind Sensor and GPS antenna [130306 - Wind Data, 129026 - COG/SOG and 129029 - GNSS Position])</i> <i>(If a GPS antenna is not present, a less-accurate reading can be calculated using only the Wind Sensor, Water Speed Sensor, and Heading Sensor [130306 - Wind Data, 127250 - Vessel Heading, and 128259 - Water Speed])</i>	Either: <ul style="list-style-type: none"> • Wind Sensor, a Water Speed Sensor, a Heading Sensor, and a GPS Antenna • Wind Sensor and a GPS Antenna • Wind Sensor, a Water Speed Sensor, and a Heading Sensor
	Beaufort Scale	130306 - Wind Data, 129026 - COG/SOG, 129029 - GNSS Position, 127250 - Vessel Heading, and 128259 - Water Speed <i>(If a Heading Sensor and Water Speed Sensor are not present, a less-accurate reading can be calculated using only the Wind Sensor and GPS antenna [130306 - Wind Data, 129026 - COG/SOG and 129029 - GNSS Position])</i> <i>(If a GPS antenna is not present, a less-accurate reading can be calculated using only the Wind Sensor, Water Speed Sensor, and Heading Sensor [130306 - Wind Data, 127250 - Vessel Heading, and 128259 - Water Speed])</i>	Either: <ul style="list-style-type: none"> • Wind Sensor, a Water Speed Sensor, a Heading Sensor, and a GPS Antenna • Wind Sensor and a GPS Antenna • Wind Sensor, a Water Speed Sensor, and a Heading Sensor
	Sunrise/Sunset	129026 - COG/SOG and 129029 - GNSS Position	GPS Antenna
Sailing	Apparent Wind Speed	130306 - Wind Data	Wind Sensor
	Apparent Wind Angle	130306 - Wind Data	Wind Sensor
	True Wind Speed	130306 - Wind Data and 128259 - Water Speed <i>(If a Water Speed Sensor is not present, a less-accurate reading can be calculated using a GPS antenna instead [129026 - COG/SOG and 129029 - GNSS Position])</i>	Either a Wind Sensor and Speed Sensor or a Wind Sensor and a GPS Antenna
	True Wind Angle	130306 - Wind Data and 128259 - Water Speed <i>(If a Water Speed Sensor is not present, a less-accurate reading can be calculated using a GPS antenna instead [129026 - COG/SOG and 129029 - GNSS Position])</i>	Either a Wind Sensor and Speed Sensor or a Wind Sensor and a GPS Antenna
	Wind VMG (Velocity Made Good)	130306 - Wind Data and 128259 - Water Speed <i>(If a Water Speed Sensor is not present, a less-accurate reading can be calculated using a GPS antenna instead [129026 - COG/SOG and 129029 - GNSS Position])</i>	Either a Wind Sensor and Speed Sensor or a Wind Sensor and a GPS Antenna
	Waypoint VMG	129284 - Nav Data	Garmin Chartplotter and GPS Antenna
	Maximum Apparent Wind Speed	130306 - Wind Data	Wind Sensor
	Maximum True Wind Speed	130306 - Wind Data and 128259 - Water Speed <i>(If a Water Speed Sensor is not present, a less-accurate reading can be calculated using a GPS antenna instead [129026 - COG/SOG and 129029 - GNSS Position])</i>	Either a Wind Sensor, a Heading Sensor, and Speed Sensor or a Wind Sensor, a Heading Sensor, and a GPS Antenna
	Opposite Tack Heading	130306 - Wind Data, 127250 - Vessel Heading, and 128259 - Water Speed <i>(If a Water Speed Sensor is not present, a less-accurate reading can be calculated using a GPS antenna instead [129026 - COG/SOG and 129029 - GNSS Position])</i>	Either a Wind Sensor, a Heading Sensor, and Speed Sensor or a Wind Sensor, a Heading Sensor, and a GPS Antenna

(Continued)

General NMEA 2000 Data Type Requirements

Category	Data Type	PGN Data Required	Typical Sender
Water	Depth	128267 - Water Depth	Depth Transducer
	Temperature	130312 - Temp, 130310 - Envir Param Old, or 130311 - Envir Param	Water Temperature Sensor
	Speed	128259 - Water Speed	Water Speed Sensor
	Set	129026 - COG/SOG, 129029 - GNSS Position, 128259 - Water Speed, and 127250 - Vessel Heading	GPS Antenna, Water Speed Sensor, and Heading Sensor
	Drift	129026 - COG/SOG, 129029 - GNSS Position, 128259 - Water Speed, and 127250 - Vessel Heading	GPS Antenna, Water Speed Sensor, and Heading Sensor
System	Time Of Day	129026 - COG/SOG and 129029 - GNSS Position	GPS Antenna
	Date	129026 - COG/SOG and 129029 - GNSS Position	GPS Antenna
	Timer	None	None
	Unit Voltage	None	None

NMEA 2000-Certified Display Device PGN Information

All data transmitted on a NMEA 2000 network are organized into groups. These groups are identified by a Parameter Group Number (PGN) that describes the type of data contained in the group. All Garmin NMEA 2000 devices use the proprietary PGN numbers 126720 and 61184. All other PGN numbers follow the NMEA 2000 standard.

The following tables list the non-proprietary PGN information for all Garmin NMEA 2000-certified display devices.

For NMEA 2000 configuration information on every available Garmin NMEA 2000-certified display device, see the owner's manual for your display device.

GPSMAP 6000/7000 Series Chartplotters

Receive		Transmit	
059392	ISO Acknowledgment	059392	ISO Acknowledgment
059904	ISO Request	059904	ISO Request
060928	ISO Address Claim	060928	ISO Address Claim
126208	NMEA - Command/Request/Acknowledge Group Function	126208	NMEA - Command/Request/Acknowledge Group Function
126464	Transmit/Receive PGN List Group Function	126464	Transmit/Receive PGN List Group Function
126992	System Time	126996	Product Information
126996	Product Information	127250	Vessel Heading
127250	Vessel Heading	127258	Magnetic Variance
127489	Engine Parameters - Dynamic	128259	Speed - Water Referenced
127488	Engine Parameters - Rapid Update	128267	Water Depth
127493	Transmission Parameters, Dynamic	129025	Position - Rapid Update
127505	Fluid Level	129026	COG & SOG - Rapid Update
128259	Speed - Water Referenced	129029	GNSS Position Data
128267	Water Depth	129283	Cross Track Error
129025	Position - Rapid Update	129284	Navigation Data
129026	COG & SOG - Rapid Update	129285	Navigation Route/Waypoint Info
129029	GNSS Position Data	129540	GNSS Sats in View
129038	AIS Class A Position Report	130306	Wind Data
129039	AIS Class B Position Report	130312	Temperature
129040	AIS Class B Extended position report		
129539	GNSS DOPs		
129540	GNSS Sats in View		
129794	AIS Class A Static and Voyage Related Data		
129808	DSC Call Information		
129809	AIS Class B "CS" Static Data Report, Part A		
129810	AIS Class B "CS" Static Data Report, Part B		
130306	Wind Data		
130310	Environmental Parameters		
130311	Environmental Parameters		
130312	Temperature		
130313	Humidity		
130314	Actual Pressure		

GPSMAP 4000/5000 Series Chartplotters

Receive		Transmit	
059392	ISO Acknowledgment	059392	ISO Acknowledgment
059904	ISO Request	059904	ISO Request
060928	ISO Address Claim	060928	ISO Address Claim
126208	NMEA - Command/Request/Acknowledge Group Function	126208	NMEA - Command/Request/Acknowledge Group Function
126464	Transmit/Receive PGN List Group Function	126464	Transmit/Receive PGN List Group Function
126992	System Time	126996	Product Information
126996	Product Information	127250	Vessel Heading
127250	Vessel Heading	127258	Magnetic Variation
127488	Engine Parameters - Rapid Update	128259	Speed - Water Referenced
127489	Engine Parameters - Dynamic	128267	Water Depth
127505	Fluid Level	129025	Position - Rapid Update
128259	Speed - Water Referenced	129026	COG & SOG - Rapid Update
128267	Water Depth	129029	GNSS Position Data
129025	Position - Rapid Update	129540	GNSS Sats in View
129026	COG & SOG - Rapid Update	129283	Cross Track Error
129029	GNSS Position Data	129284	Navigation Data
129539	GNSS DOPs	12985	Navigation - Route/Waypoint Information
129540	GNSS Sats in View	130306	Wind Data
130306	Wind Data	130312	Temperature
130310	Environmental Parameters		
130311	Environmental Parameters		
130312	Temperature		
130313	Humidity		
130314	Actual Pressure		

GPSMAP 700 Series Chartplotters

Receive		Transmit	
059392	ISO Acknowledgment	059392	ISO Acknowledgment
059904	ISO Request	059904	ISO Request
060928	ISO Address Claim	060928	ISO Address Claim
126208	NMEA - Command/Request/Acknowledge Group Function	126208	NMEA - Command/Request/Acknowledge Group Function
126464	Transmit/Receive PGN List Group Function	126464	Transmit/Receive PGN List Group Function
126996	Product Information	126996	Product Information
127245	Rudder	127250	Vessel Heading
127250	Vessel Heading	127258	Magnetic Variance
127488	Engine Parameters - Rapid Update	128259	Speed - Water Referenced
127489	Engine Parameters - Dynamic	128267	Water Depth
127493	Transmission Parameters - Dynamic	129025	Position, Rapid Update
127498	Engine Parameters - Static	129026	COG/SOG Rapid Update
127505	Fluid Level	129029	GNSS - Position Data
128259	Speed - Water Referenced	129283	Cross Track Error
128267	Water Depth	129284	Navigation Data
129038	AIS Class A Position Report	129285	Navigation - Route/WP information
129039	AIS Class B Position Report	129539	GNSS DOPs
129040	AIS Class B Extended Position Report	129540	GNSS Sats in View
129794	AIS Class A Static and Voyage Related Data	130306	Wind Data
129798	AIS SAR Aircraft position report		
129799	Radio Frequency/Mode/Power		
129802	AIS Safety Related Broadcast Message		
129808	DSC Call Information		
130306	Wind Data		
130576	Small Craft Status		
130310	Environmental Parameters		
130311	Environmental Parameters (Obsolete)		
130312	Temperature		
130313	Humidity		
130314	Actual Pressure		

GPSMAP 4x1/5x1 Series Chartplotters

Receive		Transmit	
059392	ISO Acknowledgment	059392	ISO Acknowledgment
059904	ISO Request	059904	ISO Request
060928	ISO Address Claim	060928	ISO Address Claim
126208	NMEA - Command/Request/Acknowledge Group Function	126208	NMEA - Command/Request/Acknowledge Group Function
126464	Transmit/Receive PGN List Group Function	126464	Transmit/Receive PGN List Group Function
126996	Product Information	126996	Product Information
127250	Vessel Heading	127250	Water Depth
127488	Engine Parameters - Rapid Update	128259	Speed - Water Referenced
127489	Engine Parameters - Dynamic	128267	Water Depth
127505	Fluid Level	129025	Position, Rapid Update
128259	Speed - Water Referenced	129026	COG/SOG Rapid Update
128267	Water Depth	129029	GNSS - Position Data
129038	AIS Class A Position Report	129283	Cross Track Error
129039	AIS Class B Position Report	129284	Navigation Data
129040	AIS Class B Extended Position Report	129285	Navigation - Route/WP information
129794	AIS Class A Static and Voyage Related Data	129539	GNSS DOPs
129799	Radio Frequency/Mode/Power	129540	GNSS Sats in View
129808	DSC Call Information	130306	Wind Data
130306	Wind Data		
130310	Environmental Parameters		
130311	Environmental Parameters (Obsolete)		
130312	Temperature		
130313	Humidity		
130314	Actual Pressure		

GMI 10

Receive		Transmit	
059392	ISO Acknowledgment	059392	ISO Acknowledgment
059904	ISO Request	059904	ISO Request
060928	ISO Address Claim	060928	ISO Address Claim
126208	NMEA - Command/Request/Acknowledge Group Function	126208	NMEA - Command/Request/Acknowledge Group Function
126464	Transmit/Receive PGN List Group Function	126464	Transmit/Receive PGN List Group Function
126992	System Time	126996	Product Information
126996	Product Information		
127250	Vessel Heading		
127488	Engine Parameters - Rapid Update		
127488	Boost Pressure		
127489	Coolant Pressure		
127489	Fuel Pressure		
127489	Oil Temperature		
127489	Engine Parameters - Dynamic		
127505	Fluid Level		
128259	Speed - Water Referenced		
128267	Water Depth		
129025	Position - Rapid Update		
129026	COG & SOG - Rapid Update		
129029	GNSS Position Data		
129044	Datum		
129283	Cross Track Error		
129284	Navigation Data		
129285	Navigation - Route/WP information		
129539	GNSS DOPs		
129540	GNSS Sats in View		
130306	Wind Data		
130310	Environmental Parameters		
130311	Environmental Parameters		
130312	Temperature		
130313	Humidity		
130314	Actual Pressure		

NMEA 2000-Certified Sensor PGN Information

The following tables list the non-proprietary PGN information for all Garmin NMEA 2000-certified sensors.

GPS 17x (GPS Antenna)

Transmit		Receive	
059392	ISO Acknowledgment	059392	ISO Acknowledgment
060928	ISO Address Claim	059904	ISO Request
126208	NMEA - Command/Request/Acknowledge Group Function	060928	ISO Address Claim
126464	Transmit/Receive PGN List Group Function	126208	NMEA - Command/Request/Acknowledge Group Function
126992	System Time and Date		
126996	Product Information		
129025	Position - Rapid Update		
129026	COG & SOG - Rapid Update		
129029	GNSS Position Data		
129539	GNSS DOPs		
129540	GNSS Sats in View		

GFS 10 (Garmin Fuel Sensor)

Transmit		Receive	
059392	ISO Acknowledgment	059392	ISO Acknowledgment
060928	ISO Address Claim	059904	ISO Request
126208	NMEA-Command/Request/Acknowledge Group Function	060928	ISO Address Claim
126464	Transmit/Receive PGN List Group Function	126208	NMEA-Command/Request/Acknowledge Group Function
126996	Product Information	127489	Engine Parameters - Dynamic
127489	Engine Parameters-Dynamic	127497	Trip Parameters, Engine
127497	Trip Parameters, Engine	127505	Fluid Level (when calibrated using a Garmin chartplotter or marine instrument)
127505	Fluid Level (when calibrated using a Garmin chartplotter or marine instrument)		

GRA 10 (Garmin Rudder Angle Adapter)

Transmit		Receive	
059392	ISO Acknowledgment	059392	ISO Acknowledgment
060928	ISO Address Claim	059904	ISO Request
126208	NMEA - Command/Request/Acknowledge Group Function	060928	ISO Address Claim
126464	Transmit/Receive PGN List Group Function	126208	NMEA - Command/Request/Acknowledge Group Function
126996	Product Information		
127245	Rudder		

GET 10 (Garmin Engine Tilt Adapter)

Transmit		Receive	
059392	ISO Acknowledgment	059392	ISO Acknowledgment
060928	ISO Address Claim	059904	ISO Request
126208	NMEA - Command/Request/Acknowledge Group Function	060928	ISO Address Claim

Transmit		Receive	
126464	Transmit/Receive PGN List Group Function	126208	NMEA - Command/Request/Acknowledge Group Function
126996	Product Information		
127488	Engine Parameters - Rapid Update		

GFL 10 (Garmin Fluid Level Adapter)

Transmit		Receive	
059392	ISO Acknowledgment	059392	ISO Acknowledgment
060928	ISO Address Claim	059904	ISO Request
126208	NMEA - Command/Request/Acknowledge Group Function	060928	ISO Address Claim
126464	Transmit/Receive PGN List Group Function	126208	NMEA - Command/Request/Acknowledge Group Function
126996	Product Information		
127505	Fluid Level		

GBT 10 (Garmin Bennett Trim Tab Adapter)

Transmit		Receive	
059392	ISO Acknowledgment	059392	ISO Acknowledgment
060928	ISO Address Claim	059904	ISO Request
126208	NMEA - Command/Request/Acknowledge Group Function	060928	ISO Address Claim
126464	Transmit/Receive PGN List Group Function	126208	NMEA - Command/Request/Acknowledge Group Function
126996	Product Information		
130576	Small Craft Status		

GST 10 (Garmin Water Speed and Temperature Adapter)

Transmit		Receive	
059392	ISO Acknowledgment	059392	ISO Acknowledgment
060928	ISO Address Claim	059904	ISO Request
126208	NMEA - Command/Request/Acknowledge Group Function	060928	ISO Address Claim
126464	Transmit/Receive PGN List Group Function	126208	NMEA - Command/Request/Acknowledge Group Function
126996	Product Information		
128259	Speed - Water Referenced		
130312	Temperature		

Intelliducer (Intelligent Depth Transducer–Transom Mount and Thru-Hull)

Transmit		Receive	
059392	ISO Acknowledgement	059392	ISO Acknowledgement
060928	ISO Address Claim	059904	ISO Request
126208	NMEA–Command/Request/Acknowledge Group Function	060928	ISO Address Claim
126464	Transmit/Receive PGN List Group Function	126208	NMEA–Command/Request/Acknowledge Group Function
126996	Product Information		
128267	Water Depth		
130312	Temperature		

GWS 10 (Garmin Wind Sensor)

Transmit		Receive	
059392	ISO Acknowledgment	059392	ISO Acknowledgment
060928	ISO Address Claim	059904	ISO Request
126208	NMEA - Command/Request/Acknowledge Group Function	060928	ISO Address Claim
126464	Transmit/Receive PGN List Group Function	126208	NMEA - Command/Request/Acknowledge Group Function
126996	Product Information		
130306	Wind Data		
130312	Temperature		
130314	Actual Pressure		

GHP 10 (Marine Autopilot System)

The GHP 10 autopilot system contains two components that utilize NMEA 2000, the CCU and the GHC 10.

CCU

Transmit		Recieve	
059392	ISO Acknowledgment	059392	ISO Acknowledgment
059904	ISO Request	059904	ISO Request
060928	ISO Address Claim	060928	ISO Address Claim
126208	NMEA - Command/Request/Acknowledge Group Function	126208	NMEA - Command/Request/Acknowledge Group Function
126464	Transmit/Receive PGN List Group Function	126464	Transmit/Receive PGN List Group Function
126996	Product Information	126996	Product Information
127250	Vessel Heading	127258	Magnetic Variation
		127488	Engine Parameters - Rapid Update
		129025	Position - Rapid Update
		129026	COG & SOG - Rapid Update
		129283	Cross Track Error
		129284	Navigation Data

GHC 10 (Marine Autopilot Control Unit)

Transmit		Recieve	
059392	ISO Acknowledgment	059392	ISO Acknowledgment
059904	ISO Request	059904	ISO Request
060928	ISO Address Claim	060928	ISO Address Claim
126208	NMEA - Command/Request/Acknowledge Group Function	126208	NMEA - Command/Request/Acknowledge Group Function
126464	Transmit/Receive PGN List Group Function	126464	Transmit/Receive PGN List Group Function
126996	Product Information	126996	Product Information
129025	Position - Rapid Update	127250	Vessel Heading
129026	COG & SOG - Rapid Update	127488	Engine Parameters - Rapid Update
129029	GNSS Position Data	129025	Position - Rapid Update
129283	Cross Track Error	129029	GNSS Position Data
129284	Navigation Data	129284	Navigation Data
129285	Navigation - Route/WP information	129285	Navigation - Route/WP information
129540	GNSS Sats in View		

GXM 51 (XM Weather and Radio - North America Only)

Transmit		Receive	
059392	ISO Acknowledgment	059392	ISO Acknowledgment
060928	ISO Address Claim	059904	ISO Request
126208	NMEA - Command/Request/Acknowledge Group Function	060928	ISO Address Claim
126464	Transmit/Receive PGN List Group Function	126208	NMEA - Command/Request/Acknowledge Group Function
126996	Product Information		

VHF 200

Transmit		Receive	
059392	ISO Acknowledgment	059392	ISO Acknowledgment
060928	ISO Address Claim	059904	ISO Request
126208	NMEA Request/Command/Acknowledge Group Function	060928	ISO Address Claim
126464	PGN List	126208	NMEA - Command/Request/Acknowledge Group Function
126996	Product Information	129026	COG (course over ground) and SOG (speed over ground) - Rapid Update
129799	Radio Frequency/Mode/Power		
129808	DSC Call Information	129029	GNSS (Global Navigation Satellite System) Position Data

VHF 300

Receive		Transmit	
059392	ISO Acknowledgment	059392	ISO Acknowledgment
059904	ISO Request	060928	ISO Address Claim
060928	ISO Address Claim	126208	NMEA Request/Command/Acknowledge Group Function
126208	NMEA - Command/Request/Acknowledge Group Function	126464	PGN List
129026	COG (course over ground) and SOG (speed over ground) - Rapid Update	126996	Product Information
129029	GNSS (Global Navigation Satellite System) Position Data	129038	AIS Class A Position Report
129039	AIS Class B Position Report	129040	AIS Class B Extended Position Report
129794	AIS Class A Static and Voyage Related Data	129798	AIS SAR Aircraft Position Report
129808	DSC Call Information	129799	Radio Frequency/Mode/Power
		129799	Radio Frequency/Mode/Power
		129808	DSC Call Information

AIS 300

Receive		Transmit	
059392	ISO Acknowledgment	059392	ISO Acknowledgment
059904	ISO Request	060928	ISO Address Claim
060928	ISO Address Claim	126208	NMEA Request/Command/Acknowledge Group Function
126208	NMEA - Command/Request/Acknowledge Group Function	126464	PGN List
126992	System Time	126996	Product Information
		129038	AIS Class A Position Report
		129039	AIS Class B Position Report
		129040	AIS Class B Extended Position Report
		129794	AIS Class A Static and Voyage Related Data
		129798	AIS SAR Aircraft Position Report
		129802	AIS Safety Related Broadcast Message
		129809	AIS Class B "CS" Static Data Report, Part A
		129810	AIS Class B "CS" Static Data Report, Part B

AIS 600

Receive		Transmit	
059392	ISO Acknowledgment	059392	ISO Acknowledgment
059904	ISO Request	060928	ISO Address Claim
060928	ISO Address Claim	126208	NMEA Request/Command/Acknowledge Group Function
126208	NMEA - Command/Request/Acknowledge Group Function	126464	PGN List
126992	System Time	126996	Product Information
		129038	AIS Class A Position Report
		129039	AIS Class B Position Report
		129040	AIS Class B Extended Position Report
		129794	AIS Class A Static and Voyage Related Data
		129798	AIS SAR Aircraft Position Report
		129802	AIS Safety Related Broadcast Message
		129809	AIS Class B "CS" Static Data Report, Part A
		129810	AIS Class B "CS" Static Data Report, Part B

NMEA 2000-Certified Sensor Configuration Information

Garmin NMEA 2000-certified sensors each have a *Sensor Configuration Guide* included in the package. For convenience, this section contains the configuration information for all Garmin NMEA 2000 sensor. All NMEA 2000 device configuration options are set from the NMEA 2000 configuration menu on your NMEA 2000 display device.

Important: To access the NMEA 2000 configuration menu on your display device, consult the documentation provided with your display device.

GPS 17x (GPS Antenna)

Enabling and Disabling WAAS (Wide Area Augmentation System)/EGNOS (Euro Geostationary Navigation Overlay Service)

When enabled, WAAS/EGNOS provides more-accurate position information. For more information on WAAS/EGNOS, visit www.garmin.com.

1. While viewing the NMEA 2000 configuration menu, select the GPS 17x device.
2. Select **Config > WAAS/EGNOS**.
3. On a Garmin chartplotter, select **On** or **Off**.

Setting the Speed Filter

The speed filter setting on the GPS 17x can help reduce unnecessary drift alarm triggers as well as potentially sporadic position information. The speed filter averages the data provided by the GPS 17x to provide smoother position data updates. The speed filter is most helpful when stationary or in low-speed situations.

1. While viewing the NMEA 2000 configuration menu, select the GPS 17x device.
2. Select **Config > Speed Filter**.
3. Choose from the following options:
 - **Off**—position information from the GPS 17x is provided to the NMEA 2000 network as it is gathered.
 - **On**—position information from the GPS 17x is gathered and averaged before it is provided to the NMEA 2000 network. Select the interval at which the position information is gathered.
 - **Auto**—the speed filter toggles on in low-speed situations and toggles off in high-speed situations.

Refreshing GPS Satellite Acquisition

In some situations, if you have moved the boat many miles without using the GPS 17x, for example, you can force the GPS 17x to re-initialize and find your current position.

1. While viewing the NMEA 2000 configuration menu, select the GPS 17x device.
2. Select **Config > Auto Locate**.
3. Wait for the GPS 17x to acquire satellites.

Restoring Factory Default Settings

You can restore factory default settings to the GPS 17x. You will lose all custom configuration settings when you restore factory default settings.

To restore factory default settings:

1. While viewing the NMEA 2000 configuration menu, select the GPS 17x device.
2. Select **Config > Factory Defaults**.

GFS 10 (Garmin Fuel Sensor)

 **CAUTION:** The GFS 10 is a sensor that helps you better determine the amount of fuel used on your boat. You should not rely solely on the GFS 10 for fuel-level information. Carefully compare information displayed on the unit to all available fuel-level instruments and sources.

Using Fuel-Flow Information With a Garmin Chartplotter or Marine Instrument

 **CAUTION:** The Garmin chartplotter or marine instrument must be powered on to calculate remaining fuel based on the fuel-flow rate.

Important: When using the GFS 10 to calculate remaining fuel based on the fuel-flow rate, you must specify the amount of fuel each time you add fuel to the tank.

To specify the amount of fuel added:

1. While viewing the fuel page or fuel instrument screen on your NMEA 2000 device, select **Menu**.
2. Choose from the following options:
 - **Fill Up Tank**—set the fuel level to the maximum capacity.
 - **Add Fuel to Boat**—specify the amount of fuel added.
 - **Set Total Fuel Onboard**—specify the amount of fuel currently available in the fuel tank or tanks.

Changing the Fuel Economy Source

The Garmin chartplotter or marine instrument requires a speed sensor, in addition to the GFS 10, to calculate fuel economy.

To change the fuel economy source:

1. While viewing the fuel page or fuel instrument screen on your NMEA 2000 device, select **Menu > Fuel Economy Source**.
2. Select either **GPS Speed** or **Water Speed** to specify which speed sensor is used to calculate fuel economy.

Using Fuel-Level Information With a Garmin Chartplotter or Marine Instrument

To receive fuel-level information, connect the wiring harness on the GFS 10 to the fuel gauge or fuel-level sensor of your boat according to the *GFS 10 Installation Instructions*.

To calibrate fuel-level information from the GFS 10:

1. While in still water, on the NMEA 2000 device configuration menu, select the GFS 10 device that is connected to the fuel tank you want to configure.

 **TIP:** The serial number of each GFS 10 is shown on the NMEA 2000 device configuration screen to help differentiate among multiple GFS 10 devices.

2. Select **Config > Level Calibration > Add Calibration Point** and enter a calibration point that corresponds to the current fuel level in that fuel tank.

Entering more calibration points will provide a more-accurate reading. For example, entering five calibration points (empty tank, 1/4 tank, 1/2 tank, 3/4 tank, and full tank) will provide a more-accurate reading than entering two calibration points (empty tank and full tank).

 **TIP:** For a quick calibration, start with an empty tank, and enter calibration points as you fill up the tank.

To reset the fuel-level calibration:

1. While viewing the NMEA 2000 device configuration menu, select the GFS 10 device that is connected to the fuel tank you want to configure.
2. Select **Config > Level Calibration > Reset Calibration**.

Configuring Engine and Tank Information

If you have a multi-engine or a multi-tank setup on your boat, specify which engine or tank is associated with each GFS 10.

 **TIP:** The serial number of each GFS 10 is shown on the NMEA 2000 device configuration menu to help differentiate among multiple GFS 10 devices.

To configure tank and engine information for the GFS 10:

1. While viewing the NMEA 2000 device configuration menu, select the GFS 10 device you want to configure, and select **Config**.
2. Select from the following options:
 - **Engine Number**—for a multi-engine installation, assign the selected GFS 10 to a specific engine.
 - **Tank Number**—for a multi-tank installation, assign the selected GFS 10 to a specific tank.
 - **Tank Capacity**—define the fuel capacity of the fuel tank that the selected GFS 10 is connected to.

Troubleshooting Fuel Gauge Type

When wired to a fuel gauge, the gauge type defaults to Auto Detect. If the fuel-level reading on your Garmin chartplotter or marine instrument changes with the engine RPM, the GFS 10 could be detecting the wrong type of gauge.

 **NOTE:** The fuel level changes with the motion of the boat. Perform this test when the boat is not moving.

To test the gauge-type setting:

1. When the boat is not moving, put the engine in neutral.
2. Use the throttle to increase the engine RPM. If the fuel-level reading changes with the engine RPM, change the gauge type.

To change the gauge-type setting:

1. While viewing the NMEA 2000 device configuration menu, select the GFS 10 device.
2. Select **Config > Gauge Type**.
3. Choose **1 Coil** or **2 Coil** and repeat the gauge-type setting test.

Troubleshooting the Fuel-Flow Reading

If the fuel-flow information received from the GFS 10 appears inaccurate, you can manually adjust the fuel-flow reading.

To adjust the fuel-flow reading:

1. While viewing the NMEA 2000 device configuration menu, select the GFS 10 device.
2. Select **Config > Flow Adjustment**.
3. Enter a positive or negative adjustment.

For example, when you set the Flow Adjustment to +10% , a flow reading of 20 gal./hr. (75 L/h) would change to a reading of 22 gal./hr. (82.5 L/h), because $20 \text{ gal.} \times 110\% = 22 \text{ gal.}$ ($75 \text{ L} \times 110\% = 82.5 \text{ L}$).

Restoring Factory Default Settings

You can restore factory default settings to the GFS 10. You will lose all custom configuration and calibration settings when you restore factory default settings.

To restore factory default settings:

1. While viewing the NMEA 2000 configuration menu, select the GFS 10 device.
2. Select **Config > Factory Defaults**.

GRA 10 (Garmin Rudder Angle Adapter)

NOTE: This section provides specific configuration information for the GRA 10 adapter using your compatible Garmin display device. To access the NMEA 2000 configuration menu on your display device, consult the documentation provided with your display device.

Calibrating the Rudder Angle

To use the GRA 10 adapter, you must calibrate the angle of the rudder that the adapter is associated with.

1. Turn the boat ignition key to the On position (not Start).
2. From the NMEA 2000 Devices list, select the GRA 10 device.
3. Select an option:
 - For most Garmin chartplotters, select **Review > Rudder Angle Calibration**.
 - For other Garmin marine devices, select **Config > Rudder Angle Calibration**.
4. Follow the on-screen instructions to calibrate the starboard and port rudder angles.
5. Select **OK** when the calibration is complete.

Troubleshooting the Gauge Type

When connected to a gauge, the GRA 10 adapter gauge type is set to **Auto Detect** by default, and the adapter automatically detects the type of gauge it is connected to. If the rudder-angle reading on a connected Garmin chartplotter or marine instrument changes with the engine RPM, the adapter may be detecting the wrong type of gauge.

To test the gauge-type setting:

1. When the boat is not moving, put the engine in neutral.
2. Use the throttle to increase the engine RPM. If the rudder-angle reading changes with the engine RPM, change the gauge type.

To change the gauge type:

1. From the NMEA 2000 Devices list, select the GRA 10 device.
2. Select an option:
 - For most Garmin chartplotters, select **Review > Gauge Type**.
 - For other Garmin marine devices, select **Config > Gauge Type**.
3. Select an option:
 - To automatically detect the gauge type, select **Auto Detect**.
 - To indicate a one-coil gauge, select **1 Coil**.
 - To indicate a two-coil gauge, select **2 Coil**.
4. Perform the gauge-type setting test.

Configuring the GRA 10 Adapter if the Rudder Angle Calibration and Gauge Type Selections Are Not Displayed

Depending on the version of software loaded on your Garmin marine instrument, the specific configuration options may not be displayed on the configuration screens.

To calibrate the rudder angle if the menu option is not displayed:

To use the GRA 10 adapter, you must calibrate the angle of the rudder that the adapter is associated with.

1. Turn the boat ignition key to the On position (not Start).
2. From the NMEA 2000 Devices list, select the GRA 10 device.
3. Select an option:
 - For most Garmin chartplotters, select **Review > Generic Config**.
 - For other Garmin marine devices, select **Config > Generic Configuration**.
4. Move the rudder fully to starboard and observe the angle of the rudder position, in degrees.
5. Enter the following command: **"RUDDERPOS="**

6. After the command, enter the angle of the starboard rudder position as a whole number greater than **0** and less than **180**, in degrees, followed by **Done**. For example, **RUDDERPOS=45Done**.
7. Center the rudder.
8. Enter the following command: **"RUDDERPOS=0Done"**
9. Move the rudder fully to port and observe the angle of the rudder position, in degrees.
10. Enter the following command: **"RUDDERPOS="**
11. After the command, enter the angle of the port rudder position as a whole number less than **0** and greater than **-180**, in degrees, followed by **Done**. For example, **RUDDERPOS=-45Done**.

To configure the gauge type if the menu option is not displayed:

When connected to a gauge, the GRA 10 adapter gauge type is set to **Auto Detect** by default, and the adapter automatically detects the type of gauge it is connected to. When you troubleshoot the gauge-type setting, if the rudder-angle reading on a connected Garmin chartplotter or marine instrument changes with the engine RPM, the adapter may be detecting the wrong type of gauge.

1. From the NMEA 2000 Devices list, select the GRA 10 device.
2. Select an option:
 - For most Garmin chartplotters, select **Review > Generic Config**.
 - For other Garmin marine devices, select **Config > Generic Configuration**.
3. Enter the following command: **"GAUGRAYPE="**
4. After the command, enter one of the following options:
 - To automatically detect the gauge type, enter **0**, followed by **Done**. For example, **GAUGRAYPE=0Done**.
 - To indicate a one-coil gauge, enter **1**, followed by **Done**. For example, **GAUGRAYPE=1Done**.
 - To indicate a two-coil gauge, enter **2**, followed by **Done**. For example, **GAUGRAYPE=2Done**.

Restoring Factory Default Settings

You will lose all custom configuration settings when you restore factory default settings.

1. From the NMEA 2000 Devices list, select the GRA 10 device.
2. Select an option:
 - For most Garmin chartplotters, select **Review > Generic Config**.
 - For other Garmin marine devices, select **Config > Generic Configuration**.
3. Select **Yes**.

GET 10 (Garmin Engine Tilt Adapter)

NOTE: This section provides specific configuration information for the GET 10 adapter using your compatible Garmin display device. To access the NMEA 2000 configuration menu on your display device, consult the documentation provided with your display device.

Calibrating the Engine Tilt

To use the GET 10 adapter, you must calibrate the tilt of the engine with which the adapter is associated.

1. Turn the boat ignition key to the On position (not Start).
2. From the NMEA 2000 Devices list, select the GET 10 device.
3. Select an option:
 - For most Garmin chartplotters, select **Review > Engine Tilt Calibration**.
 - For other Garmin marine devices, select **Config > Engine Tilt Calibration**.
4. Follow the on-screen instructions to calibrate the engine tilt.
5. Select **OK** when the calibration is complete.

Configuring the Engine Number

If your boat has multiple engines, you can indicate which engine each GET 10 adapter is associated with.

1. From the NMEA 2000 Devices list, select the GET 10 device.
2. Select an option:
 - For most Garmin chartplotters, select **Review > Engine Number**.
 - For other Garmin marine devices, select **Config > Engine Number**.
3. Select the number of the engine that the adapter is associated with.
4. Select **Done**.

Troubleshooting the Gauge Type

When connected to a gauge, the GET 10 adapter gauge type is set to **Auto Detect** by default, and the adapter automatically detects the type of gauge it is connected to. If the engine-tilt reading on a connected Garmin chartplotter or marine instrument changes with the engine RPM, the adapter may be detecting the wrong type of gauge.

To test the gauge-type setting:

1. When the boat is not moving, put the engine in neutral.
2. Use the throttle to increase the engine RPM. If the engine-tilt reading changes with the engine RPM, change the gauge type.

To change the gauge type:

1. From the NMEA 2000 Devices list, select the GET 10 device.
2. Select an option:
 - For most Garmin chartplotters, select **Review > Gauge Type**.
 - For other Garmin marine devices, select **Config > Gauge Type**.
3. Select an option:
 - To automatically detect the gauge type, select **Auto Detect**.
 - To indicate a one-coil gauge, select **1 Coil**.
 - To indicate a two-coil gauge, select **2 Coil**.
4. Perform the gauge-type setting test.

Configuring the GET 10 Adapter if the Engine Tilt Calibration, Engine Number, and Gauge Type Selections Are Not Displayed

Depending on the version of software loaded on your Garmin marine instrument, the specific configuration options may not be displayed on the configuration screens.

To calibrate the engine tilt if the menu option is not displayed:

To use the GET 10 adapter, you must calibrate the tilt of the engine that the adapter is associated with.

1. Turn the boat ignition key to the On position (not Start).
2. From the NMEA 2000 Devices list, select the GET 10 device.
3. Select an option:
 - For most Garmin chartplotters, select **Review > Generic Config**.
 - For other Garmin marine devices, select **Config > Generic Configuration**.
4. Set the engine tilt to the full-up position. The engine tilt is at 100%.
5. Enter the following command: **“ENGINETILT=100Done”**
6. Set the engine tilt to the full-down position. The engine tilt is at 0%.
7. Enter the following command: **“ENGINETILT=0Done”**

To configure the engine number if the menu option is not displayed:

If your boat has multiple engines, you can indicate which engine each GET 10 adapter is associated with.

1. From the NMEA 2000 Devices list, select the GET 10 device.
2. Select an option:

- For most Garmin chartplotters, select **Review > Generic Config**.
 - For other Garmin marine devices, select **Config > Generic Configuration**.
3. Enter the following command: “**INSTANCE=**”
 4. After the command, enter a whole number between **1** and **253**, which indicates the engine number, followed by **Done**. For example, **INSTANCE=2Done** indicates that the adapter is associated with engine number 2.

To configure the gauge type if the menu option is not displayed:

When connected to a gauge, the GET 10 adapter gauge type is set to **Auto Detect** by default, and the adapter automatically detects the type of gauge it is connected to. When you troubleshoot the gauge-type setting, if the engine-tilt reading on a connected Garmin chartplotter or marine instrument changes with the engine RPM, the adapter may be detecting the wrong type of gauge.

1. From the NMEA 2000 Devices list, select the GET 10 device.
2. Select an option:
 - For most Garmin chartplotters, select **Review > Generic Config**.
 - For other Garmin marine devices, select **Config > Generic Configuration**.
3. Enter the following command: “**GAUGETYPE=**”
4. After the command, enter one of the following options:
 - To automatically detect the gauge type, enter **0**, followed by **Done**. For example, **GAUGETYPE=0Done**.
 - To indicate a one-coil gauge, enter **1**, followed by **Done**. For example, **GAUGETYPE=1Done**.
 - To indicate a two-coil gauge, enter **2**, followed by **Done**. For example, **GAUGETYPE=2Done**.

Restoring Factory Default Settings

You will lose all custom configuration settings when you restore factory default settings.

1. From the NMEA 2000 Devices list, select the GET 10 device.
2. Select an option:
 - For most Garmin chartplotters, select **Review > Factory Defaults**.
 - For other Garmin marine devices, select **Config > Factory Defaults**.
3. Select **Yes**.

GFL 10 (Garmin Fluid Level Adapter)

NOTICE: This section provides specific configuration information for the GFL 10 adapter using your compatible Garmin display device. To access the NMEA 2000 configuration menu on your display device, consult the documentation provided with your display device.

Configuring the NMEA 2000 Fluid Type

You can indicate the type of fluid that is in the tank with which each GFL 10 adapter is associated.

1. From the NMEA 2000 Devices list, select the GFL 10 device.
2. Select an option:
 - For most Garmin chartplotters, select **Review > N2K Fluid Type**.
 - For other Garmin marine devices, select **Config > N2K Fluid Type**.
3. Select a fluid type.
4. Select **OK**.

Configuring the Tank Number

If your boat has multiple fluid tanks, you can indicate which tank each GFL 10 adapter is associated with.

1. From the NMEA 2000 Devices list, select the GFL 10 device.
2. Select an option:
 - For most Garmin chartplotters, select **Review > Tank Number**.

- For other Garmin marine devices, select **Config > Tank Number**.
3. Select a tank number.
 4. Select **OK**.

Configuring the NMEA 2000 Tank Capacity

You can indicate the capacity of the fluid tank that the GFL 10 adapter is associated with.

1. From the NMEA 2000 Devices list, select the GFL 10 device.
2. Select an option:
 - For most Garmin chartplotters, select **Review > N2K Tank Capacity**.
 - For other Garmin marine devices, select **Config > N2K Tank Capacity**.
3. Select the tank capacity.
4. Select **Done**.

Calibrating the Fluid Level

To use the GFL 10 adapter, you must calibrate the fluid level of the tank that the adapter is associated with, using a minimum of two calibration points. The greater the number of fluid calibration points, the greater the accuracy of the reading on the fluid-level gauge.

1. Turn the boat ignition key to the On position (not Start).
2. From the NMEA 2000 Devices list, select the GFL 10 device.
3. Select an option:
 - For most Garmin chartplotters, select **Review > Level Calibration > Add Calibration Point**.
 - For other Garmin marine devices, select **Config > Level Calibration > Add Calibration Point**.
4. Select the percentage of fluid currently in the tank, based on the total tank capacity.
5. Select **Done**.
6. Change the level of the fluid in the tank.
7. Select **Add Calibration Point**.
8. Select the percentage of fluid currently in the tank, based on the total tank capacity.
9. Select **Done**.
10. Repeat steps 6 through 9 to add additional, optional fluid-level calibration points.

Troubleshooting the Tank Number

If multiple GFL 10 adapters are assigned to the same NMEA 2000 fluid type, each adapter is assigned a unique tank number automatically. If the “Invalid NMEA 2000 tank configuration” error message appears, you must assign a unique tank number to each adapter.

For example, if two adapters are assigned the NMEA 2000 fluid type value of Live Well and the error message appears, you must assign each adapter a unique tank number.

1. From the NMEA 2000 Devices list, select the GFL 10 device.
2. Select an option:
 - For most Garmin chartplotters, select **Review > Tank Number**.
 - For other Garmin marine devices, select **Config > Tank Number**.
3. Select a tank number.
4. Select **OK**.

Troubleshooting the Gauge Type

When connected to a gauge, the GFL 10 adapter gauge type is set to **Auto Detect** by default, and the adapter automatically detects the type of gauge it is connected to. If the fluid-level reading on a connected Garmin chartplotter or marine instrument changes with the engine RPM, the adapter may be detecting the wrong type of gauge.

NOTE: The fluid level changes when the boat is moving. Test the gauge-type setting when the boat is not moving.

To test the gauge-type setting:

1. When the boat is not moving, put the engine in neutral.
2. Use the throttle to increase the engine RPM. If the fluid-level reading changes with the engine RPM, change the gauge type.

To change the gauge type:

1. From the NMEA 2000 Devices list, select the GFL 10 device.
2. Select an option:
 - For most Garmin chartplotters, select **Review > Gauge Type**.
 - For other Garmin marine devices, select **Config > Gauge Type**.
3. Select an option:
 - To automatically detect the gauge type, select **Auto Detect**.
 - To indicate a one-coil gauge, select **1 Coil**.
 - To indicate a two-coil gauge, select **2 Coil**.
4. Perform the gauge-type setting test.

Resetting the Fluid Level Calibration

You can reset the fluid-level calibration of the tank that the GFL 10 adapter is associated with.

1. From the NMEA 2000 Devices list, select the GFL 10 device.
2. Select an option:
 - For most Garmin chartplotters, select **Review > Level Calibration**.
 - For other Garmin marine devices, select **Config > Level Calibration**.
3. Select **Reset Calibration**.
4. Select **Yes**.
5. Calibrate the fluid level.

Configuring the GFL 10 Adapter if the Tank Number and Fluid Type Selections Are Not Displayed

Depending on the version of software loaded on your Garmin marine instrument, the specific configuration options may not be displayed on the configuration screens.

To configure the tank number if the menu option is not displayed:

If your boat has multiple fluid tanks, you can indicate which tank each GFL 10 adapter is associated with.

1. From the NMEA 2000 Devices list, select the GFL 10 device.
2. Select an option:
 - For most Garmin chartplotters, select **Review > Generic Config**.
 - For other Garmin marine devices, select **Config > Generic Configuration**.
3. Enter the following command: **"INSTANCE="**
4. After the command, enter a whole number between **1** and **16**, which indicates the tank number, followed by **Done**.
For example, **INSTANCE=2Done** indicates that the adapter is associated with tank number 2.

To configure the fluid type if the menu option is not displayed:

You can indicate the type of fluid that is in the tank that each GFL 10 adapter is associated with.

1. From the NMEA 2000 Devices list, select the GFL 10 device.
2. Select an option:
 - For most Garmin chartplotters, select **Review > Generic Config**.
 - For other Garmin marine devices, select **Config > Generic Configuration**.
3. Enter the following command: **"FLUIDTYPE="**
4. After the command, enter a number between 0 and 5 to indicate the fluid type as defined in the following table, followed by **Done**.

For example, **FLUIDTYPE=1Done** indicates that the tank contains fresh water.

Fluid Type	FLUIDTYPE Value	Fluid Type	FLUIDTYPE Value
Fuel	0	Live well	3
Fresh water	1	Oil	4
Waste water	2	Black water (sewage)	5

Restoring Factory Default Settings

When you restore factory default settings, you will lose all custom configuration settings except fluid-level calibration.

1. From the NMEA 2000 Devices list, select the GFL 10 device.
2. Select an option:
 - For most Garmin chartplotters, select **Review > Factory Defaults**.
 - For other Garmin marine devices, select **Config > Factory Defaults**.
3. Select **Yes**.

GBT 10 (Garmin Bennett Trim Tab Adapter)

NOTE: This section provides specific configuration information for the GBT 10 adapter using your compatible Garmin display device. To access the NMEA 2000 configuration menu on your display device, consult the documentation provided with your display device.

Calibrating the Trim Tab Position

To use the GBT 10 adapter, you must calibrate the position of the trim tabs the adapter is associated with.

NOTE: If you only adjust your trim tabs within a limited range of motion on a regular basis, calibrate the GBT 10 adapter using your normal range instead of the full range. Only the calibrated range will be displayed on your chartplotter or marine instrument.

1. From the NMEA 2000 Devices list, select the GBT 10 device.
2. Select an option:
 - For most Garmin chartplotters, select **Review > Trim Tab Calibration**.
 - For other Garmin marine devices, select **Config > Trim Tab Calibration**.
3. Follow the on-screen instructions to calibrate the trim tab position.

Configuring the GBT 10 Adapter if the Trim Tab Calibration Selection Is Not Displayed

Depending on the version of software loaded on your Garmin marine instrument, the specific configuration options may not be displayed on the configuration screens.

To calibrate the trim tab position if the menu option is not displayed:

To use the GBT 10 adapter, you must calibrate the position of the trim tabs that the adapter is associated with. You can enter a minimum of two, and a maximum of sixteen, trim tab positions. For greater accuracy, enter more trim tab positions.

1. While viewing the NMEA 2000 configuration menu, select the GBT 10 device.
2. Select **Config > Generic Configuration**.
3. Enter the following command: **"CALIBRATION=1"**
4. Move both trim tabs to the highest position. When the trim tabs are in the highest position, they should be at or near 0% of their full range of motion.
5. Enter the following command: **"TRIMTABPOS="**
6. After the command, enter the percentage of the highest trim tab position as a whole number between 0 and 100, and select Done. For example, **TRIMTABPOS=0Done**.
7. Move both trim tabs to the lowest position. When the trim tabs are in the lowest position, they should be at or near 100% of their full range of motion.

8. Enter the following command: **“TRIMTABPOS=”**
9. After the command, enter the percentage of the lowest trim tab position as a whole number between 0 and 100, and select Done. For example, **TRIMTABPOS=100Done**.
10. To enter an additional, optional trim tab position, move both trim tabs to a new position, and observe the trim tab position as a percentage of the full range of motion of the trim tab.
11. Enter the following command: **“TRIMTABPOS=”**
12. After the command, enter the percentage of the trim tab position as a whole number between 0 and 100, and select Done. For example, **TRIMTABPOS=50Done**.
13. Repeat steps 10 through 12 to enter additional, optional trim tab positions.

Restoring Factory Default Settings

You will lose all custom configuration settings when you restore factory default settings.

1. From the NMEA 2000 Devices list, select the GBT 10 device.
2. Select an option:
 - For most Garmin chartplotters, select **Review > Factory Defaults**.
 - For other Garmin marine devices, select **Config > Factory Defaults**.
3. Select **Yes**.

GST 10 (Garmin Water Speed and Temperature Adapter)

NOTE: This section provides specific configuration information for the GST 10 adapter using your compatible Garmin display device. To access the NMEA 2000 configuration menu on your display device, consult the documentation provided with your display device.

Calibrating the Water Speed

To use the GST 10 adapter, you must calibrate the water speed.

1. From the NMEA 2000 Devices list, select the GST 10 device.
2. Select an option:
 - For most Garmin chartplotters, select **Review > Calibrate Water Speed**.
 - For other Garmin marine devices, select **Config > Calibrate Water Speed**.
3. Follow the on-screen instructions to calibrate the water speed.

Assigning a NMEA 2000 Temperature Source

To use the GST 10 adapter, you must select the source for the temperature data.

1. From the NMEA 2000 Devices list, select the GST 10 device.
2. Select an option:
 - For most Garmin chartplotters, select **Review > N2K Temp. Source**.
 - For other Garmin marine devices, select **Config > N2K Temp. Source**.
3. Select the location of the temperature sensor.

Configuring the Temperature Offset

If the temperature data displayed on the gauge connected to the GST 10 adapter is not the same as temperature data displayed on other devices, you can configure the temperature offset to increase or decrease the displayed temperature by a specific amount.

1. From the NMEA 2000 Devices list, select the GST 10 device.
2. Select an option:
 - For most Garmin chartplotters, select **Review > Temperature Offset**.
 - For other Garmin marine devices, select **Config > Temperature Offset**.
3. Select the temperature offset as a positive or negative decimal number, in degrees.

4. Select **Done**.

Troubleshooting the Sensor Number

If multiple GST 10 adapters are assigned to the same NMEA 2000 temperature source, each adapter is assigned a unique sensor number automatically. If the “Invalid NMEA 2000 temperature configuration” error message appears, you must assign a unique sensor number to each adapter.

For example, if two adapters are assigned the NMEA 2000 temperature source value of Live Well and the error message appears, you must assign each adapter a unique number.

1. From the NMEA 2000 Devices list, select the GST 10 device.
2. Select an option:
 - For most Garmin chartplotters, select **Review > Sensor Number**.
 - For other Garmin marine devices, select **Config > Sensor Number**.
3. Select a sensor number.
4. Select **OK**.

Configuring the GST 10 Adapter if the Water Speed, Location, Temperature Offset, and Sensor Number Selections Are Not Displayed

Depending on the version of software loaded on your Garmin marine instrument, the specific configuration options may not be displayed on the configuration screens.

To calibrate the water speed if the menu option is not displayed:

To use the GST 10 adapter, you must calibrate the water speed.

1. From the NMEA 2000 Devices list, select the GST 10 device.
2. Select an option:
 - For most Garmin chartplotters, select **Review > Generic Config**.
 - For other Garmin marine devices, select **Config > Generic Configuration**.
3. Ensure that the boat is stationary; the engine should be off or idling.
4. Enter the following command: **“WATERSPEED=0Done”**
5. Accelerate the boat to cruising speed and observe the maximum speed, in miles per hour.
6. Bring the boat to a stop; the engine should be off or idling.
7. Enter the following command: **“WATERSPEED=”**
8. After the command, enter a positive decimal number that indicates the maximum cruising speed in miles per hour, followed by **Done**. For example, **WATERSPEED=35.5Done**.

To configure the temperature source if the location menu option is not displayed:

To use the GST 10 adapter, you must select the source for the temperature data.

1. From the NMEA 2000 Devices list, select the GST 10 device.
2. Select an option:
 - For most Garmin chartplotters, select **Review > Generic Config**.
 - For other Garmin marine devices, select **Config > Generic Configuration**.
3. Enter the following command: **“TEMPSOURCE=”**
4. After the command, enter a number between **0** and **8**, or **13**, to indicate the source of the temperature data as defined in the following table, followed by **Done**.
For example, **TEMPSOURCE=6Done** indicates that the bait well is the source for the temperature data.

Location	TEMPSOURCE Value	Location	TEMPSOURCE Value
Water	0	Live well	5
Air outside	1	Bait well	6
Air inside	2	Refrigeration	7
Engine room	3	Heating system	8
Main cabin	4	Freezer	13

To configure the temperature offset if the menu option is not displayed:

If the temperature data displayed on the gauge connected to the GST 10 adapter is not the same as temperature data displayed on other devices, you can configure the temperature offset to increase or decrease the displayed temperature by a specific amount.

1. From the NMEA 2000 Devices list, select the GST 10 device.
2. Select an option:
 - For most Garmin chartplotters, select **Review > Generic Config**.
 - For other Garmin marine devices, select **Config > Generic Configuration**.

3. Enter the following command: **“TEMPOFFSET=”**

4. After the command, enter a positive or negative decimal number, followed by **Done**.

For example, **TEMPOFFSET=-2.5Done** indicates that the temperature readings displayed on the gauge connected to the GST 10 adapter will be decreased by 2.5 degrees Celsius.

To configure the sensor number if the menu option is not displayed:

If multiple GST 10 adapters are assigned to the same NMEA 2000 temperature source, each adapter is assigned a unique sensor number automatically. If the “Invalid NMEA 2000 temperature configuration” error message appears, you must assign a unique sensor number to each adapter.

For example, if two adapters are assigned the NMEA 2000 temperature source value of Live Well and the error message appears, you must assign each adapter a unique number.

1. From the NMEA 2000 Devices list, select one of the GST 10 devices assigned to the same temperature source.
2. Select an option:
 - For most Garmin chartplotters, select **Review > Generic Config**.
 - For other Garmin marine devices, select **Config > Generic Configuration**.

3. Enter the following command: **“INSTANCE=”**

4. After the command, enter a positive decimal number, followed by **Done**.

5. Repeat steps 1–4 for each GST 10 device assigned to the same temperature source.

For example, if two GST 10 adapters are assigned the value of Live Well, assigning **INSTANCE=1** to the first adapter and assigning **INSTANCE=2** to the second adapter prevents the error message.

Restoring Factory Default Settings

You will lose all custom configuration settings when you restore factory default settings.

1. From the NMEA 2000 Devices list, select the GST 10 device.
2. Select an option:
 - For most Garmin chartplotters, select **Review > Factory Defaults**.
 - For other Garmin marine devices, select **Config > Factory Defaults**.
3. Select **Yes**.

Intelliducer (Intelligent Depth Transducer—Transom Mount and Thru-Hull)

Setting the Keel Offset

Adjust the **Keel Offset** to display a depth reading from the water line or from the lowest point of the boat (keel) rather than the actual location of the Intelliducer.

To adjust the keel offset:

1. While viewing the NMEA 2000 device configuration menu, select a specific Intelliducer and select **Config > Keel Offset**.
2. Enter the measured distance from the Intelliducer location to the water line or to the keel of the boat.
 - If you are measuring down to the keel (Intelliducer installed at the water line), enter a (+) positive number.
 - If you are measuring up to the water line (Intelliducer installed on the keel), enter a (-) negative number.

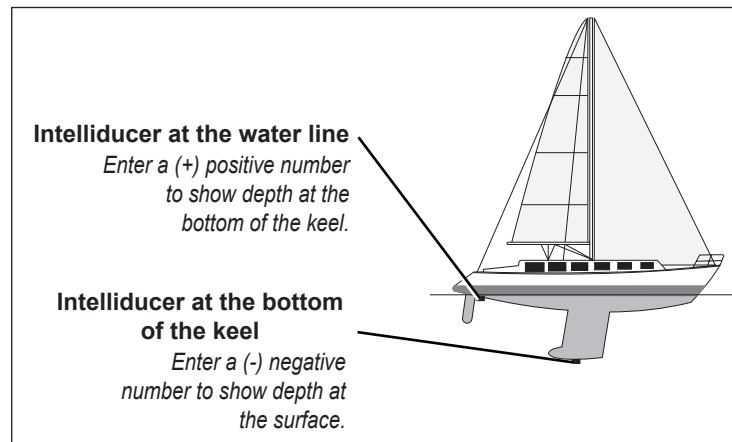

Keel Offset

GWS 10 (Garmin Wind Sensor)

Configuring the Wind Angle Offset (Orientation)

When mounting the sensor, you must adjust the angle offset if you did not orient the GWS 10 as described in the *GWS 10 Installation Instructions*.

To configure the wind angle offset (orientation):

1. While viewing the NMEA 2000 device information, select **Config > Wind Angle Offset**.
2. Select the angle in degrees to adjust for the difference in orientation.

TIP: The angles are configured clockwise around the mast of the boat. For example, 90 degrees is on the starboard side of the boat, and 270 degrees is on the port side.

Configuring the Wind Speed Filter

The wind speed filter governs how quickly the NMEA 2000-compatible display device shows a change in the wind speed. A lower filter setting shows changes in the wind speed more gradually, and may stabilize the display.

To configure the wind speed filter:

1. While viewing the NMEA 2000 device information, select **Config > Wind Speed Filter**.
2. Choose from the following options to adjust the filter settings.
 - **Off**—the wind speed data is not filtered.
 - **On**—select a lower number to show a change in the wind speed more gradually, and help the gauge needle or wind speed number to move or change more steadily.
 - **Auto**—automatically adjusts the filter settings based on wind conditions.

Configuring the Wind Angle Filter

The wind angle filter governs how quickly the NMEA 2000-compatible display device shows a change in the wind angle. A lower filter setting shows changes in the wind angle more gradually, and may stabilize the display.

To configure the wind angle filter:

1. While viewing the NMEA 2000 device information, select **Config > Wind Angle Filter**.
2. Choose from the following options to adjust the filter settings.
 - **Off**—the wind angle data is not filtered.
 - **On**—select a lower number to update the display device less often, and help the gauge needle or wind angle number to move or change more steadily.
 - **Auto**—automatically adjusts the filter settings based on wind conditions.

Configuring the GWS 10 if the Filter and Offset Selections Are Not Displayed

Depending on the version of software loaded on your Garmin marine instrument, the specific configuration options may not be displayed on the configuration screens.

To configure the wind angle offset if the menu option is not displayed:

1. Select **Generic Configuration** to specify data for the filter and offset settings.
2. Enter the following command: **"ANGLEOFFSET="**
3. Follow the command with a number between 0 and 359, in degrees (for example: ANGLEOFFSET=180).

To configure the wind angle filter if the menu option is not displayed:

1. Select **Generic Configuration** to specify data for the filter and offset settings.
2. Enter the following command: **"ANGLEFILTER="**
3. Follow the command with a number between 0 and 254, representing a time constant in increments of 0.25 second, or 255 to represent the Automatic setting (for example: ANGLEFILTER=12).

To configure the wind speed filter:

1. Select **Generic Configuration** to specify data for the filter and offset settings.
2. Enter the following command: **"SPEEDFILTER="**
3. Follow the command with a number between 0 and 254, representing a time constant in increments of 0.25 second, or 255 to represent the Automatic setting (for example: SPEEDFILTER=215).

NMEA 2000 Checklist

Use this checklist to confirm your NMEA 2000 installation.

	Is the NMEA 2000 network connected to power, and is the power balanced correctly on the network? (page 5)
	Is the NMEA 2000 network power connected through the ignition switch—if not, did you install a switch? (page 5)
	Is the NMEA 2000 power cable grounded? Is the bare wire connected to the same ground location? (page 5)
	Is the NMEA 2000 network backbone built using linear construction? (page 4)
	Are there terminators on both ends of the NMEA 2000 network? (page 7)
	Are all drop cables less than 20 ft. (6 m)? (page 8)

**For the latest free software updates (excluding map data) throughout the life of your
Garmin products, visit the Garmin Web site at www.garmin.com.**



© 2009–2012 Garmin Ltd. or its subsidiaries

Garmin International, Inc.
1200 East 151st Street, Olathe, Kansas 66062, USA

Garmin (Europe) Ltd.
Liberty House, Hounsdown Business Park, Southampton, Hampshire, SO40 9LR UK

Garmin Corporation
No. 68, Zhangshu 2nd Road, Xizhi Dist., New Taipei City, 221, Taiwan (R.O.C.)

www.garmin.com